

WFC-03 6Z HC RF 24

WFC-03 6Z HC RF 230

WFC-03 10Z HC RF 24

WFC-03 10Z HC RF 230

Water Floor Controller Wireless
Heating & Cooling
Installation manual

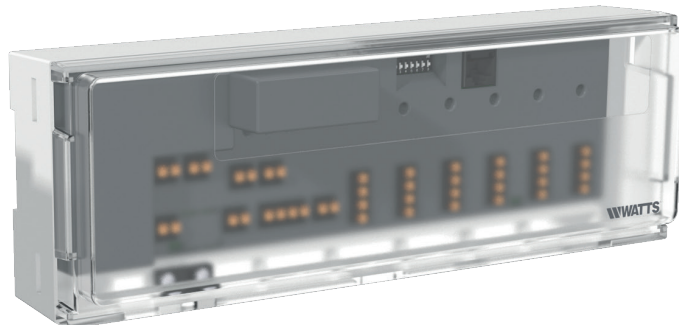

USER GUIDE

GENERAL INFORMATION	3
Safety warnings and operating instructions.....	3
Application	3
PRESENTATION	3
Functions.....	3
Box content.....	3
First installation.....	3
PRODUCT DESCRIPTION.....	4
LED color meanings	4
Keys	4
DIP switch configuration	5
USB stick	5
INPUTS / OUTPUTS.....	6
Power Supply	6
Heating/cooling Input.....	6
Pump Output.....	7
Security input	7
Humidity detection input.....	8
NC/NO actuators.....	9
External antenna.....	9
SYSTEM CONFIGURATION.....	10
System configuration without central unit.....	10
System configuration with central unit.....	12
OTHER FEATURES	14
Anti Grip Feature.....	14
Reset.....	14
Trouble shooting	14
TECHNICAL CHARACTERISTICS.....	15
Dimensions & weight	15
DIRECTIVES.....	16

1. General information

1.1 Safety warnings and operating instructions

This product should be installed preferably by a qualified professional. Subject to observation of the above terms, the manufacturer shall assume the liability for the equipment as provided by legal stipulations.

All instructions in this Installation & Operation manual should be observed when working with the controller. Failures due to improper installation, improper use or poor maintenance are voiding manufacturer liability.



Any attempt to repair voids the responsibility and the obligation to guarantee and replacement from the manufacturer. 2012/19/EU (WEEE directive): Products marked with this symbol cannot be disposed of as unsorted municipal waste in the European Union. For proper recycling, return this product to your local supplier upon the purchase of equivalent new equipment, or dispose of it at designated collection points. For more information see: www.recyclethis.info

1.2 Application

The controller has been designed for use in residential rooms, office spaces and industrial facilities. Verify that the installation complies with existing regulations before operation to ensure proper use of the installation.

2. Presentation

The Connecting box WFC HC RF is especially designed to control your Under Floor Heating and Cooling system. It allows easy and quick connection of thermostats and actuators.

4 versions are available:

	230V version	24V version
6 zones	WFC-03 6Z HC RF 230	WFC-03 6Z HC RF 24 (Require external 230V/24V transformer: TRF03 230/24)
10 zones	WFC-03 10Z HC RF 230	WFC-03 10Z HC RF 24 (Require external 230V/24V transformer: TRF03 230/24)

2.1 Functions

It has integrated multiple functions:

- Wall mounted or mounter on DIN Rail
- Push-in cable connections with strain relief
- LED status indication and DIP switch for device setting
- Manage 6 or 10 zones with 2 actuators per zone
- Easy merging of the zones on the same thermostat
- Multiple systems configuration
- H&C input (230V and volt free signal)
- Water temperature measurement (Probe not supplied) for humidity detection
- Pump or boiler output (230V and volt free signal)
- Anti-Grip management
- Contact for temperature limitation
- Internal RF antenna, optional external antenna
- Work with NC and NO actuators
- USB connectivity for software update and data log

2.2 Box content



2.3 First installation

There are 2 ways to install the controller:

- Wall mounted using 2 screws
- Mounted on a DIN Rail

3. Product description

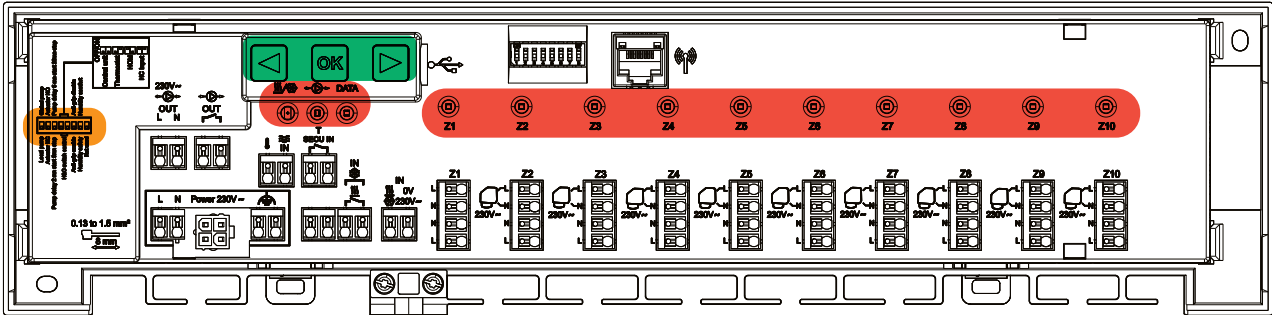

3.1 LED color meanings (In Red)

# led	Meanings
Heat and Cool led (Blue/Red)	<ul style="list-style-type: none"> • Fix Red = Heating mode • Fix Blue = Cooling mode • Red blinking (in heating) or blue blinking (in cooling) = Security detection • Red / Blue blinking = RF error (with WFC-03 HC RF, WFC-03 HCM RF 230, BT-CT02 RF, BT-CT03 RF, internal antenna). In case of RF error, the system switches in Heating mode.
Pump/Drier Led (Green/Blue/Red)	<ul style="list-style-type: none"> • Fix Green = Pump is triggered • Red blinking = System error (security detection / humidity sensor error/...) • Blue blinking = Global humidity detection • Blue flashing = Humidity configuration problem
Data Led (Red/Green)	<ul style="list-style-type: none"> • Green blinking= Ongoing data log
LED per zone (Red/Green)	<ul style="list-style-type: none"> • Green blinking = RF transmission/reception • Fix Red = Heating or cooling demand in the zone • Red blinking = RF error with the thermostat • Red blinking on all zones = RF antenna error <p>In case of RF error with WFC03-HCM RF or BT-CT02 RF, the system switches in Heating mode</p>

3.2 Keys (In Green)

3 capacitive keys are available.



3.3 DIP switch configuration (In Orange)

DIP switch number	Function	Value (default: OFF)		Configuration	Description
DIP1	Controller function	OFF		Local Pump	See 4.3
		ON		Global pump	
DIP2	Actuator types	OFF		NC actuator	See 4.6
		ON		NO actuator	
DIP3	Pump start delay (for the first actuator in demand) and actuator stop delay (for the last actuator in demand)	OFF		2min/5min	See 4.3 and 4.6
		ON		5min/5min	
DIP4 and DIP5	H&C switch control	OFF	OFF	Central Unit BT-CT02 RF	See 4.2
		OFF	ON	Master thermostat BT-D03 RF	
		ON	OFF	WFC-03 HCM RF	
		ON	ON	WFC-03 HC RF	
DIP6	Anti Grip	OFF		Enabled	See 6.1
		ON		Disabled	
DIP7	Humidity management	OFF		Safety approach	See 4.5
		ON		Comfort approach	
DIP8	Humidity sensor	OFF		ON/OFF sensor	See 4.5
		ON		Pipe temperature sensor	

3.4 USB stick



USB connectivity allows:

- To update the Software of the controller
- To record data for system monitoring (datalog)

For the software update, please refer to wattswater.eu for getting the file, put the file on an USB stick. The name of the file should be WATnew.mot.

- Insert the USB stick on the controller
- Switch OFF/ON the controller
- During update:
 - . Green LED are power On from Z1 to Z6/Z10
 - . All LED become red
 - . Red LED are power Off from Z6/Z10 to Z1
- After update, you can remove the USB stick

For trouble shooting, datalog is useful to record data on an ASCII file stored on the USB dongle for trouble shooting.

By pressing  for 5 seconds, the master goes in Features menu. The LED of the first zone blinks either in Red (Datalog is enable) or in green (Datalog is disable). You can enable or disable the datalog by clicking on .

Long press on  allow to leave the feature menu (Otherwise there is a timeout of 10s before leaving automatically the feature menu).

1 log file is created every 14 days. In the file, a record is made every 10min.

4. Inputs / Outputs

4.1 Power Supply

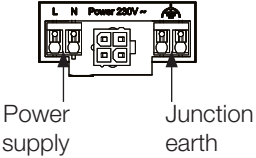
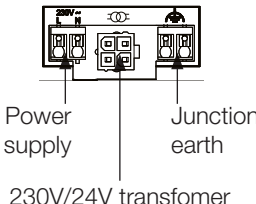
<p>WFC-03 6Z HC RF 230 / WFC-03 10Z HC RF 230</p>	 <p>Power supply Junction earth</p>
<p>WFC-03 6Z HC RF 24 / WFC-03 10Z HC RF 24</p> <p>Require to use transformer supplied by Watts (4 cables): WAT TRF03 230/24</p>	 <p>Power supply Junction earth</p> <p>230V/24V transformer</p>

4.2 Heating/cooling Input

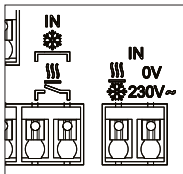

Purpose:

This input allows switching the regulation mode for the system: Heating or cooling.

Source of the signal:

- A mechanical switch
- A Heat Pump
- A BT-WR02 RF paired on the BT-CT02 RF central unit as an ON/OFF device. This solution allows getting a remote control of the H&C mode from the application.

Format of the signal:

The input could be free contact or live contact 230V.

Mode	Free contact	Live contact
Heating	Opened	No signal
Cooling	Closed	230Vac

Only one device in the system should be able to select the H&C mode. Other possible H&C switch signal source (See 3.3).

- Central unit (Set Manual H&C mode in the installer menu of the central).
- WFC-03 HCM RF 230 which embeds an H&C input.
- Digital thermostat configured as a Master H&C thermostat in manual or automatic mode (only one thermostat per installation).

If you have multiple WFC-03 HC RF in the system, the H&C mode should be controlled by only one controller:

- Without central, the system considers the controller set as the Main WFC-03 HC RF (Please refer to 5.1.2)
- With central:
 - . The controller which controls the H&C mode. DIP#4DIP#5= WFC-03 HC RF.
 - . The controller which does not control the H&C mode. DIP#4DIP#5= Central Unit BT-CT02 RF.

DIP4	DIP5	Changeover signal H&C request by
OFF	OFF	Central unit (BT-CT02 RF)
OFF	ON	Thermostat
ON	OFF	Heat&cool module (WFC-03 HCM RF)
ON	ON	Connecting box (WFC-03 HC RF)

4.3 Pump Output

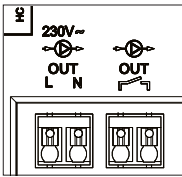

There are 2 outputs:

- Live contact output (230Vac).
- Free contact output.

These outputs can be used to trigger:

- A zone valve
- A pump
- A boiler or heat pump

The 2 outputs are triggered when there are a heating or cooling demand

- In the controller if DIP switch 1 = local
- In the system if DIP switch 1 = Global

See 3.3

The delay between the heating or cooling demand and the pump activation is configurable.

- Pump starts 2 minutes after heating or cooling demand if DIP switch 3 = OFF
- Pump starts 5 minutes after heating or cooling demand if DIP switch 3 = ON

See 3.3

The purpose is to take into account the latency of the actuator.

4.4 Contact for temperature limitation

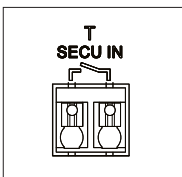

This is a security input (Free contact).

Closed Contact	No security detection
Opened Contact	Overheating or overcooling detection

The security input should be used on a controller with a pump.

When the contact is opened:

- The local pump output is stopped (even if DIP1 = ON, i.e. global pump on the controller).
- The actuators are closed.
- The Pump/Drier Led is red blinking.
- The Heat and Cool led is Red blinking (in heating) or blue blinking (in cooling).
- If the controller is a sub controller, the heating or cooling demand is not sent to the main controller.

You can use a contact thermostat for thermal security. You can install 2 contact thermostats in serial to protect against both overheating and overcooling (The security input is valid in both heating and cooling mode).

The product is delivered with a strap on the connector.

Please note that the pump of the WFC-03 HCM RF is triggered when at least one pump of the multiple WFC-03 HC RF installed in the system is triggered.

4.5 Humidity detection input

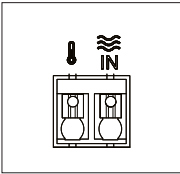

The product has a humidity detection input.

2 possible types of signal according to DIP8 (See 3.3)

- A humidity contact sensor.
- Water temperature sensor (CTN 10kΩ): Require BT-D03 RF RH thermostat.

1. Humidity contact sensor.

DIP8 = OFF.

Format of the signal.

The input is a free contact.

No Humidity	Opened contact
Humidity detected	Closed contact

In cooling mode, when humidity is detected, the controller:

- Stops the pump signal.
- Closes all actuators.
- Sends the humidity alarms to all other WFC-03 HC RF in the system.
- Requests the WFC-03 HCM RF to enable the dehumidifier.

If the controller is a sub controller, the cooling demand is not sent to the main controller.

2. Water temperature sensor.

DIP8 = ON.

There are 2 usages of the water temperature measurement.

2.1 Humidity detection.

In cooling mode, for each zone, the controller computes the dew point based on the ambient temperature and relative humidity sent by each thermostat (Thermostat with relative humidity sensor is required).

When the water temperature reaches the dew point in one zone, the controller:

Comfort approach: DIP7 = ON	Keep the actuator of the zone opened during one hour then close the actuator and stop the cooling demand in the zone if the humidity alarm is still triggered.
Safety approach: DIP7 = OFF	Close the actuator of the zone and stop the cooling demand of the zone.

- Enable remote dehumidifier of the zone.
- Requests the heat&cool module WFC-03 HCM RF to enable the global dehumidifier for at least 15min and up the disappearance of the alarm if no remote dehumidifier is available in the zone.

If the controller is a sub controller, the cooling demand of the zone is not sent to the main controller.

2.2 Heating&Cooling mode detection.

When DIP4 = ON and DIP5 = OFF (H&C switch control = WHC-03 HC RF) and DIP8 = ON:

. The water temperature is used to detect automatically the H&C mode.

- If water temperature > 24°C, the system is in heating mode.
- If water temperature < 20°C, the system is in cooling mode.

This feature is useful when the Heat Pump switches automatically in heating or cooling mode and has no output to inform the system.

- If the WFC-03 HCM RF measures a water temperature:
 - . The temperature is sent to the WHC-03 HC RF which can be used if there is no water temperature sensor.
- If H&C input= cool mode:
 - . The system switches in cooling mode regardless the water temperature.

4.6 NC/NO actuators

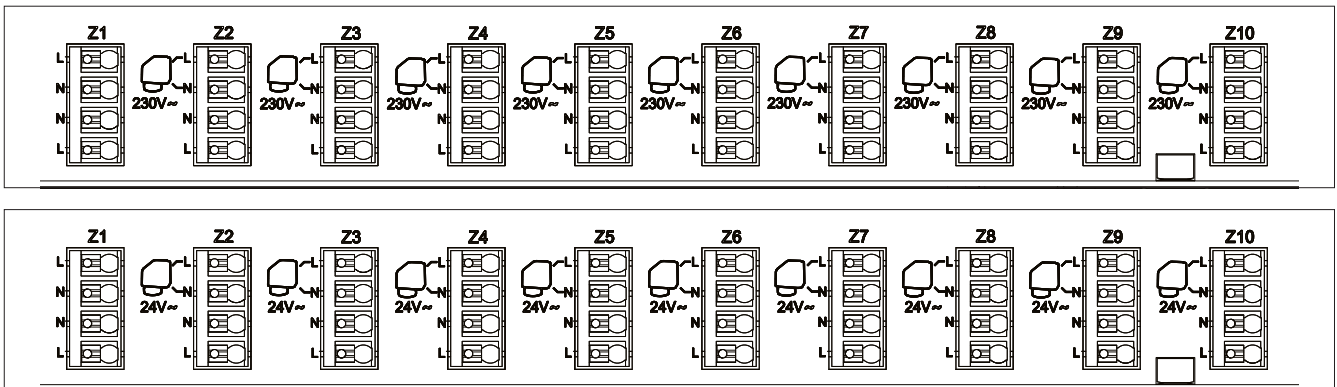

Connect one NC or NO actuator per connector.

- 230V actuators for WFC-03 6Z HC RF 230 and WFC-03 10Z HC RF 230.
- 24V actuators for WFC-03 6Z HC RF 24 and WFC-03 10Z HC RF 24.

The type of actuators is defined by DIP2.

It is necessary to use the same type for all actuators.

When there is a heating or cooling demand in one zone, the actuator is triggered immediately.

When the heating or cooling demand is stopped, the actuator is closed immediately except if this is the last actuator opened in the controller. In that case, the delay before starting to close the actuator is dependent of DIP3 (See 3.3).

- If DIP3 = OFF, the system waits 5mn before closing the last actuator.
- If DIP3 = ON, the system waits 20mn before closing the last actuator.

Justification:

Many heat pumps have a built in turn-off delay (to avoid successive switch OFF/ON). In this case, the heat pump continues to run for x minutes beyond the actual switch-off time. It is important to keep at least one circuit open unless there is a buffer tank, hydraulic switch or bypass in the installation.

4.7 External antenna

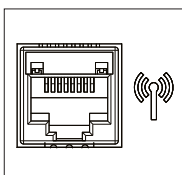

The controller embeds an internal antenna.

If require, an external antenna can be connected to improve the RF communication. It could be useful if the controller is installed inside a metallic box. In that case, you need to install the external antenna outside the metallic box.



Please respect the mounting to optimize sensitivity and avoid any dysfunction.

Antenna must be installed:

- Outside the metallic box.
- In vertical position.
- And at least at 50cm of metallic parts.

If you have several antenna (several controllers), they must be placed at minimum 80cm of each other.



The active antenna must be mounted vertically.

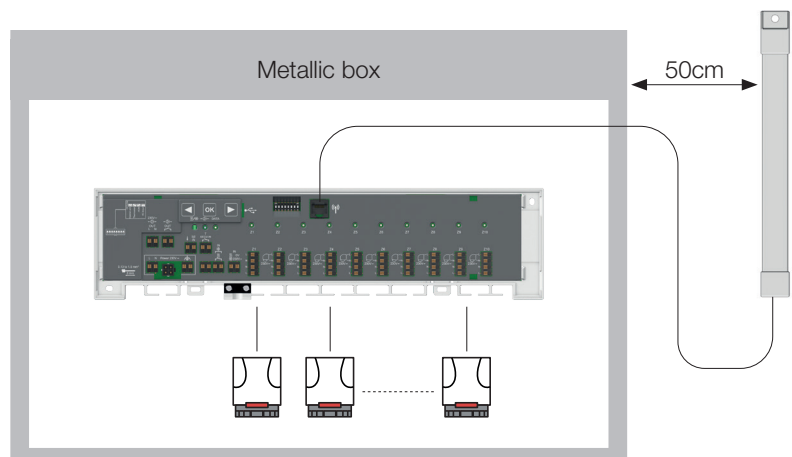





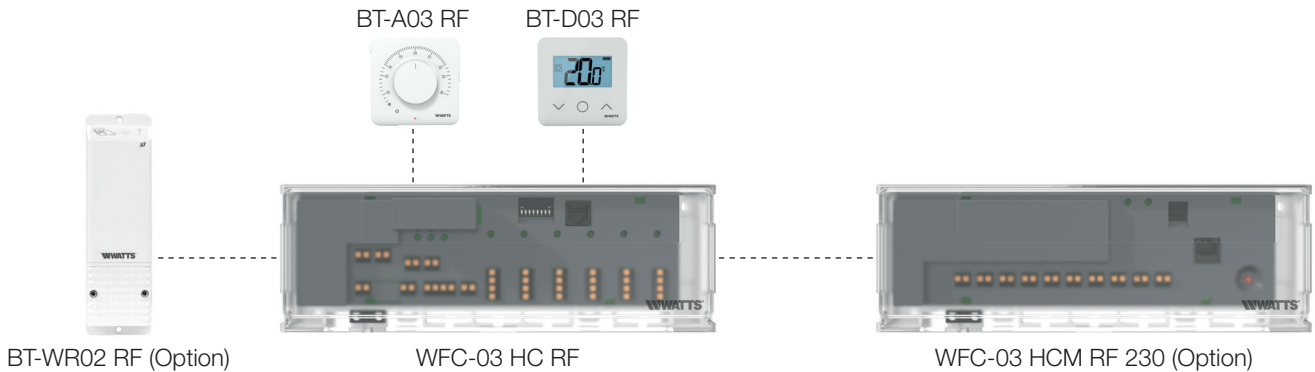

5. System configuration

5.1 System configuration without central unit

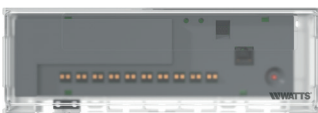
5.1.1 Standalone installation: only one controller or multiple controllers without interconnection.

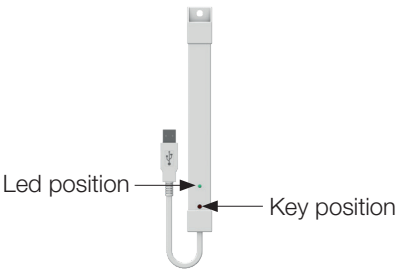

Device 1	Device 2	Remarks
 <p>By pressing OK for 5 seconds, the controller goes in RF pairing menu.</p> <p>By using ◀ and ▶ select zone 1 (LED blinks red), press OK to enter in Pairing with thermostat mode. The green blinking LED is a position indicator.</p> <p>Move the green blinking LED with ◀ and ▶ to select the zone(s) to be paired.</p> <p>Select/deselect the zone with OK.</p> <p>Selected zone is fix red but keeps blinking green (position indicator).</p> <p>Already paired zone is fix green.</p>	 <p>Thermostats : Put product in RF pairing mode (refer to corresponding instruction manual).</p>	<p>If RF pairing is done, the LEDs of the zones selected on the WFC-03 HC RF must turn off and the thermostats must exit the pairing mode.</p> <p>To pair another thermostat, you need to enter/start the mode again.</p> <p>Exit of the controller pairing menu: Long press on ◀.</p>
 <p>By pressing OK for 5 seconds, the controller goes in RF pairing menu.</p> <p>By using ◀ and ▶ select zone 3 (Red led), press OK to enter in Pairing with a slave device mode.</p> <p>All LEDs are blinking green.</p>	 <p>Put the device in RF pairing mode (Press 10s on the button).</p>	<p>When link is done, WFC-03 HC RF returns to the RF pairing menu and WFC-03 HCM RF 230 returns to normal mode.</p> <p>Exit of the controller pairing menu: Long press on ◀.</p> <p>REMARK: only one WFC-03 HCM RF 230 per installation.</p>

Device 1	Device 2	Remarks
 <p>By pressing OK for 5 seconds, the controller goes in RF pairing menu. By using ◀ and ▶ select zone 3 (Red led), press OK to enter in Pairing with a slave device mode. All LEDs are blinking green.</p>	 <p>Put the device in RF pairing mode.</p>	<p>When link is done WFC-03 HC RF and BT-WR02 RF return to pairing mode. This configuration allows a remote pump output. Exit of the controller pairing menu: Long press on ◀.</p>
 <p>By pressing OK for 5 seconds, the controller goes in RF pairing menu. By using ◀ and ▶ select zone 3 (Red led), press OK to enter in Pairing with a slave device mode. All LEDs are blinking green.</p>	 <p>Put the RF repeater in RF Link mode (press 3 seconds on the button).</p>	<p>When RF link is done, WFC-03 HC RF returns to pairing mode and the led on the repeater becomes green fix. Exit of the controller pairing menu: Long press on ◀.</p>

5.1.2 Multiple controller's installation.

If there are multiple interconnected controllers in the installation, there are 1 main-controller and up to 3 sub-controllers. The main controllers centralizes the information for the sub-controllers. If a WFC-03 HCM RF 230 is used, it should be paired to the main-controller.

- The main-controller propagates the Heat and Cool mode to the sub-controllers. This information could come from the WFC-03 HCM RF 230 or from a Master Digital thermostat according to the DIP4 and DIP5 (See 3.3).
- The main-controller could handle the pump signal of the whole installation according to DIP1 (See 3.3).

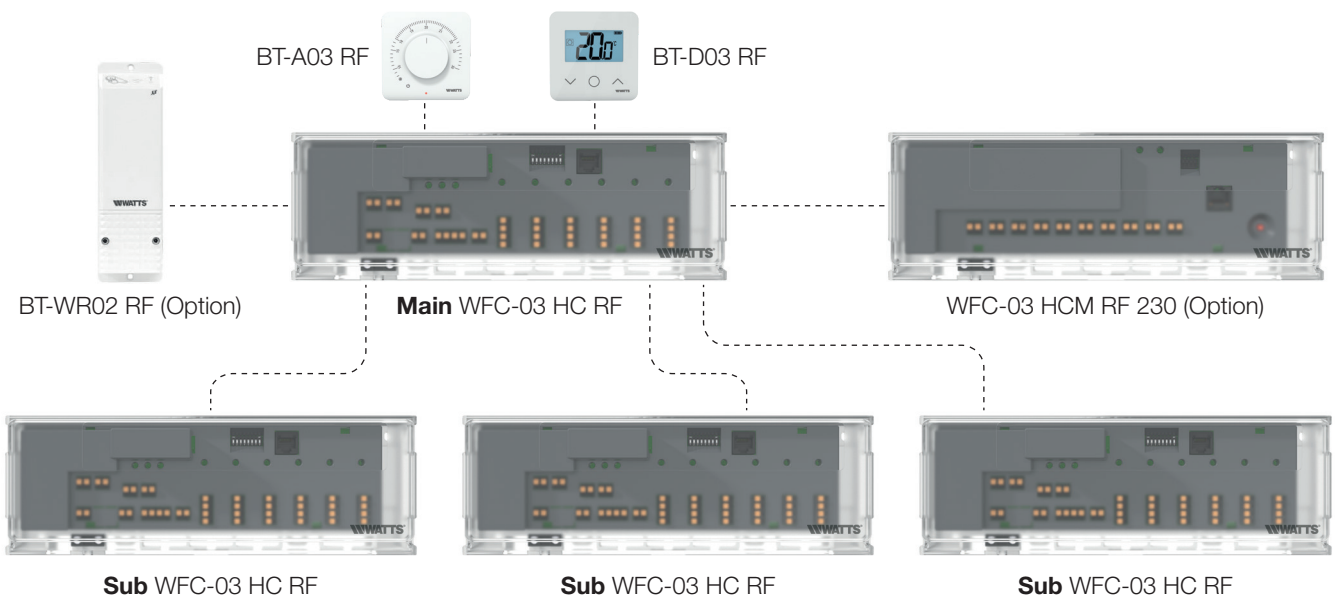

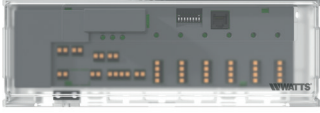
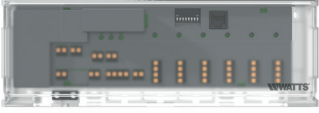

Device 1: Main Controller	Device 2: Sub-controller	Remarks
First, all ratio thermostats must be paired with the respective WFC-03 HC RF controller! See 5.1.1		
 <p>By pressing OK for 5 seconds, the controller goes in RF pairing menu. By using ◀ and ▶ select zone 3 (Red blinking led), press OK to enter in Pairing with a slave device mode. All LEDs are blinking green.</p>	 <p>By pressing OK for 5 seconds, the controller goes in RF pairing menu. By using ◀ and ▶ select zone 2 (Red led), press OK to enter in Pairing with a master device mode. All LEDs are blinking red.</p>	<p>When RF pairing is done, both WFC-03 HC RF return to pairing mode.</p> <p>Exit of the controller pairing menu: Long press on ◀.</p>

5.2 System configuration with central unit

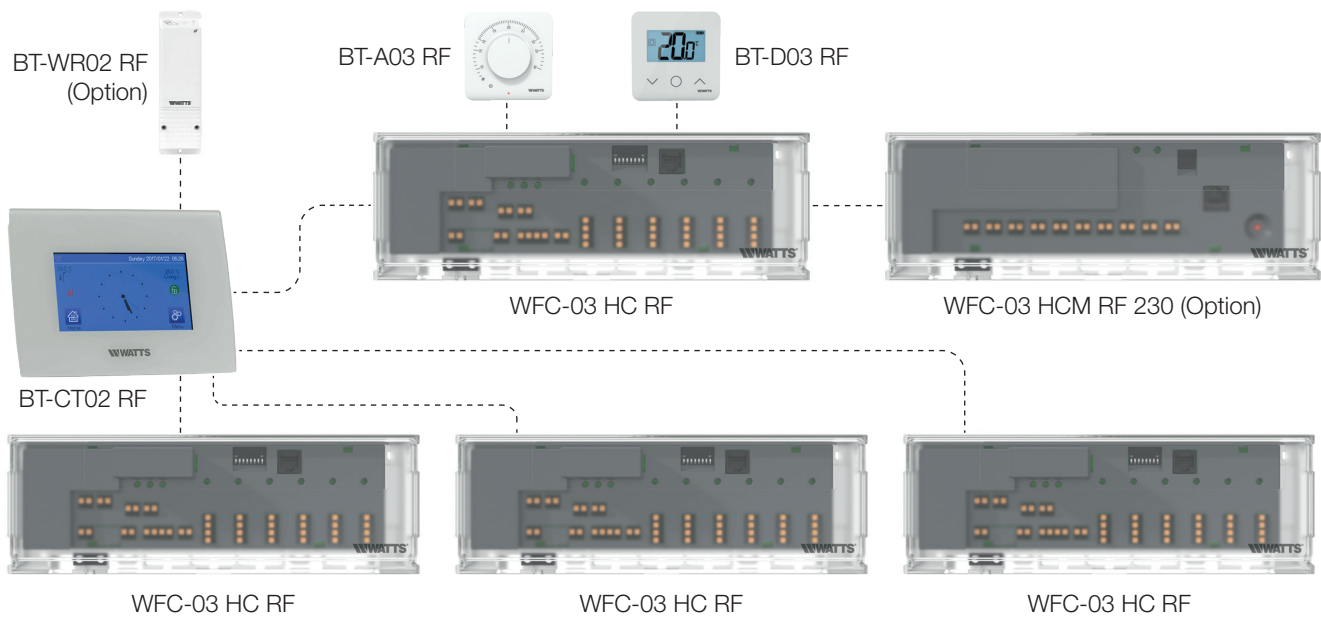
The central unit centralizes the communication between controllers.



Device 1: WFC-03 HC RF	Device 2: BT-CT02 RF	Remarks
First, all ratio thermostats must be paired with the respective WFC-03 HC RF controller! See 5.1.1		
 <p>By pressing OK for 5 seconds, the controller goes in RF pairing menu. By using ◀ and ▶ select zone 2 (Red blinking led), press OK to enter in Pairing with a master device mode. All LEDs are blinking red.</p>	 <p>Put the device in RF pairing mode. Select the first room.</p>	<p>When RF pairing is done, both WFC-03 HC RF and BT-CT02 RF exits the pairing mode.</p> <p>Exit of the controller pairing menu: Long press on ◀.</p>

5.3 Control a dehumidifier per room

There are 2 ways to detect humidity:



- At controller level using the humidity detection input (See 4.5).
- At the room level if the thermostat embeds a relative humidity sensor.

When humidity is detected, there are 2 ways to trigger dehumidifier:

- A global dehumidifier is triggered by the WFC-03 HCM RF if the feature is activated on the WFC-03 HCM RF.
- A dehumidifier is triggered on the room level where the humidity is detected.

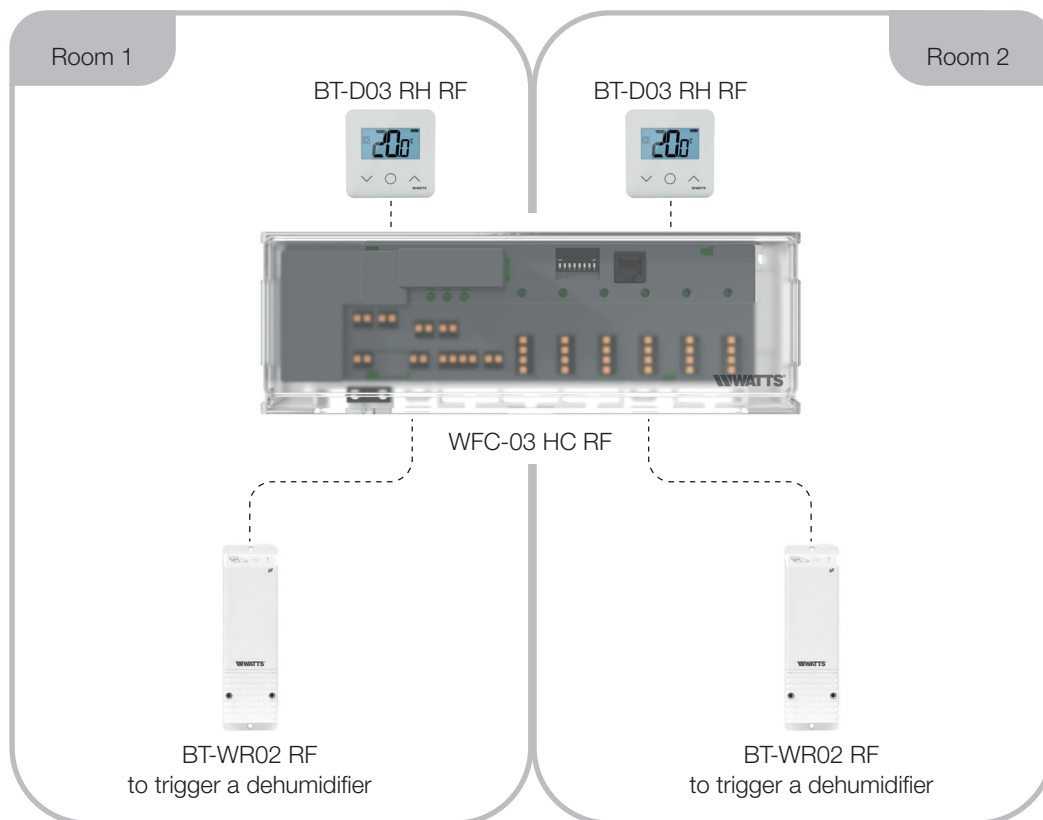
For that last case, you need to pair a BT-WR02 RF receiver on each zone of the controller in order to trigger a dehumidifier.



Device 1: WFC-03 HC RF	Device 2: BT-WR02 RF	Remarks
 <p>By pressing OK for 5 seconds, the controller goes in RF pairing menu.</p> <p>By using ◀ and ▶ select zone 4 (Red blinking led), press OK to enter in dehumidifier Pairing mode.</p> <p>Choose the zones with ◀ and ▶.</p> <p>Zones are defined by paired thermostat channels. For example if TH1 = Z1, TH2 = Z2+Z3 and TH3 = Z4+Z5+Z6.</p> <p>Navigation proposes 3 zones to pair a dehumidifier on (Z1), (Z2+Z3) and (Z4+Z5+Z6).</p> <p>Select/deselect the zone with OK (You can select only one zone per dehumidifier) Cursor is blinking green.</p> <p>Selected zone is blinking red and green.</p> <p>Already paired zone is fix green.</p> <p>(To remove a dehumidifier, select a zone in green, then press simultaneously on ◀ and ▶ up to get the zone blinking in green).</p>	 <p>Put the device in RF pairing mode</p>	<p>When RF pairing is done, bWFC-03 HC RF exits the pairing mode.</p> <p>Exit of the controller pairing menu: Long press on ◀.</p>

6. Other Features

6.1 Anti Grip Feature

The feature is enable using DIP6 (See 3.3). If the valves are not active during a week, a complete exercise is triggered (actuator + pump outputs + Heat/cool demand sent to the WFC-03 HCM RF 230).

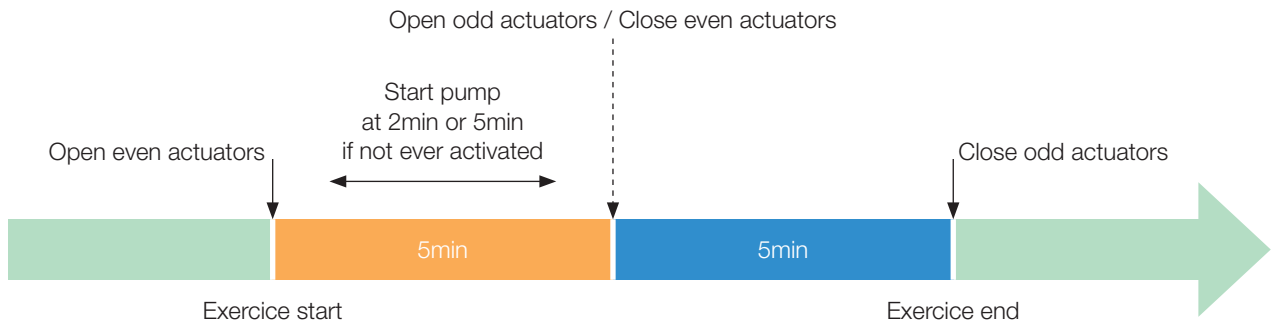

6.2 Reset

In case of dysfunction, it may be required to reset the product to factory setting. By pressing for 5 seconds, the master goes in Reset menu.

Then by pressing simultaneously on , and up to getting all zone LED in red, the controller reset is triggered and the product restarts.

6.3 Trouble shooting

Symptom #	Trouble	Description	Trouble shooting
Red or blue blinking on Heat and Cool led. And Red blinking on Pump/Drier Led.	Security detection.	The contact of the security input is opened.	If you not using a security thermostat, make sure, you have installed a strap on the security thermostat input. Otherwise control the temperature of the pipe (too hot in heating mode, too cold in cooling mode).
Red / Blue blinking on Heat and Cool led.	RF Issue.	The controller has lost the connection with a RF device other than a thermostat.	Check distance between devices. If the controller is installed within a metallic box, use an external antenna located outside the metallic box. A RF repeater may be required.
Fast Blue flashing on Pump/Drier Led.	Humidity configuration problem	CTN measurement on H&C input whereas the DIP8 = OFF. ON/OFF input on H&C input whereas the DIP8 = ON.	Check CTN and DIP switch setting
Red blinking on 1 zone.	RF error with the thermostat.	The controller has lost the connection with the thermostat.	Check distance between the controller and the thermostat. A RF repeater may be required.
Red blinking on all zones.	RF antenna error.	The controller has lost all RF connections (Thermostat and other devices).	External antenna may be required.

7. Technical characteristics

	<ul style="list-style-type: none"> • WFC-03 6Z HC RF 24 / WFC-03 6Z HC RF 230 • WFC-03 10Z HC RF 24 / WFC-03 10Z HC RF 230
Electrical protection	Class II with functional earth
IP Protection	IP30
Shipping and storage temperature	-10°C to 50°C (14°F to 122°F)
Power supply	230 Vac \pm 10% 50Hz
Output maximum load (2 outputs)	Relay: 5A
Actuators	230V /24V NC/NO up to 2W
Compatibility	<ul style="list-style-type: none"> • BT-A03 RF • BT-D03 RF • BT-DP03 RF • WFC-03 HCM RF 230 • BT-CT02 RF / BT-CT03 RF • BT-WR02 FC RF

7.1 Dimensions & weight

WFC-03 6Z HC RF 24 and WFC-03 6Z HC RF 230:

Weight: 0,990 kg

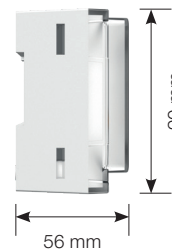
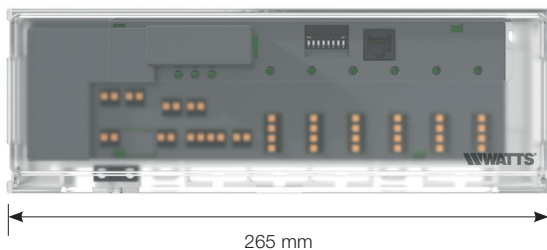

WFC-0310Z HC RF 24 and WFC-03 10Z HC RF 230:

Weight: 1,090 kg

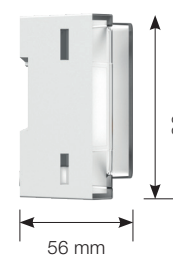
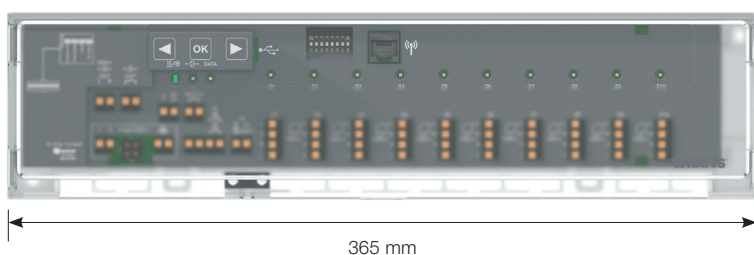

8. Directives

Designation	Description	Link
Low Voltage Directive (LVD)	The Low Voltage Directive (LVD) (2014/35/EU) ensures that electrical equipment within certain voltage limits provides a high level of protection for European citizens, and benefits fully from the Single Market.	2014/35/UE
Electromagnetic Compatibility (EMC) Directive 2014/30/EU	The Electromagnetic Compatibility (EMC) Directive 2014/30/EU ensures that electrical and electronic equipment does not generate, or is not affected by, electromagnetic disturbance.	2014/30/UE
Restriction of the use of certain hazardous substances Directive (RoHS) 2011/65/EU	Directive on the restriction of the use of certain hazardous substances in electrical and electronic equipment.	2011/65/EU
Waste Electrical & Electronic Equipment Directive (WEEE)	The WEEE Directive (2012/19/EU) aims to reduce the amount of waste electrical and electronic equipment that ends up in landfill.	2012/19/EU
Ecodesign Commission Regulation	Ecodesign requirements for local space heaters.	2015/1188
Radio Equipment Directive (RED) 2014/53/EU	The Radio Equipment Directive 2014/53/EU (RED) establishes a regulatory framework for placing radio equipment on the market.	2014/53/EU



The descriptions and photographs contained in this product specification sheet are supplied by way of information only and are not binding. Watts Industries reserves the right to carry out any technical and design improvements to its products without prior notice. Warranty: All sales and contracts for sale are expressly conditioned on the buyer's assent to Watts terms and conditions found on its website at www.wattswater.eu Watts hereby objects to any term, different from or additional to Watts terms, contained in any buyer communication in any form, unless agreed to in a writing signed by an officer of Watts.



Watts Electronics S.A.S.
B.P. N°10 - Z.A. des Tourettes • 43800 ROSIERES • France
Tél. +33 (0)4 71 57 40 49 • Fax. +33 (0)4 71 57 40 90
Sales-rosieres@wattswater.com • www.wattswater.fr
Watts contacts in Europe: <https://wattswater.eu/watts/contacts/>