

CLIMATIC CONTROL-H



INSTALLATION AND USER GUIDE
CLIMATIC CONTROL -----

GB
26-36

INSTALLATION AND OPERATION MANUAL

ClimaticControl-H Heating Controller

⚠ IMPORTANT!

Before starting work the installer should carefully read this Installation & Operation Manual, and make sure all instructions contained therein are understood and observed.

ClimaticControl-H should be mounted, operated and maintained by specially trained personnel only. Personnel in the course of training are only allowed to handle the product under the supervision of an experienced fitter. Subject to observation of the above terms, the manufacture shall assume the liability for the equipment as provided by legal stipulations.

All instructions in this Installation & Operation manual should be observed when working with the control. Any other application shall not comply with the regulations. The manufacturer shall not be liable in case of incompetent use of the control. Any modifications and amendments are not allowed for safety reasons. ClimaticControl-H maintenance may be performed by service shops approved by the manufacturer only.

The functionality of the control depends on the model and equipment. This installation leaflet is part of the product and has to be obtained.

Subject to technical modification!

| | |
|---|-----------|
| 1. APPLICATION | 26 |
| 2. REFERENCES, SYMBOLS AND ABBREVIATIONS | 27 |
| 3. SAFETY INSTRUCTIONS | 27 |
| 4. DISPLAY | 27 |
| 5. INSTALLATION AND ELECTRIC CONNECTIONS | 28 |
| 5.1. CONTROLLER INSTALLATION | 28 |
| 5.2. ELECTRIC CONNECTIONS | 28 |
| 5.3. ROOM TEMPERATURE – DIRECT PLUG IN | 29 |
| 6. TYPES OF OPERATING MODES / PROGRAM MENU | 30 |
| 6.1 TYPES OF OPERATING MODES | 30 |
| 6.2 PROGRAM MENUS | 31 |
| 7. SYSTEM PARAMETERS MENU | 34 |
| 7.1 SYSTEM PARAMETERS SETTING | 34 |
| 7.2 HEATING CURVES | 35 |
| 8. TECHNICAL DATA / MATERIALS | 35 |
| 9. TROUBLE-SHOOTING | 36 |

1. APPLICATION

- ClimaticControl-H is developed for variable flow temperature control in heating systems particular in low-temperature installations like floor heating systems. The flow temperature is controlled depending on the outside temperature following a heating curve.
- Using the controller the operation of a water floor heating system can be adapted to the actual demands of the system. In particular, the control can be used in apartments where users have their own individual living habits. A room temperature thermostat can also be connected. The control has a 7-day programmer including 9 factory set programs and 4 user defined programs.
- The control is normally used in conjunction with a hydraulic control unit which includes a circulation pump, a two- or three-way mixing valve and a valve actuator.
- The controllers have been designed for use in dry environments, e.g. in residential rooms, office spaces and industrial facilities.
- Verify that the installation complies with existing regulations before operation to ensure proper use of the installation.

2. REFERENCES, SYMBOLS AND ABBREVIATIONS

For better understanding in this document references are used in the form of symbols and abbreviations, which are described below.

| | | | |
|---|--|------------|---|
| ➔ | Reference to further documents | FBH | Floor heating |
| ⓘ | Important information and application hints | FH | Radiant heating (general) |
| ⚠ | Safety information or Important information about functions | FRG | Hydraulic control unit with pump and mixing valve |
| Ⓞ | OK-button (OK) | HKV | Manifold |
| ⏪ | Control button Left (◀) | MuB | Installation and operation manual |
| ⏩ | Control button Right (▶) | TB | Temperature limiter |
| + | Plus button (+) | UWP | Circulation pump |
| - | Minus button (-) | WE | Boiler / heat generator |

3. SAFETY INSTRUCTIONS



Before starting work disconnect power supply!

All installation and wiring work related to the controller must be carried out only when de-energized. The appliance should be connected and commissioned by qualified personnel only. Make sure to adhere to valid safety regulations, in particular to VDE 0100 (German standard governing power installations of nominal voltages ≤ 1000 VAC).

⚠ The controllers are neither splash- nor drip-proof. Therefore, they must be mounted at a dry place.

⚠ Do not interchange the connections of the sensors and the 230V connections under any circumstances! Interchanging these connections may result in life endangering **electrical hazards** or the destruction of the appliance and the connected sensors and other appliances.

4. DISPLAY

- 1: Operating modes
- 2: Keyboard is locked
- 3: Service Installation Menu
- 4: Manual operation / program override active (display of temperature offset)
- 5: a) display temperature (°C / °F)
b) display time (12 h / 24 h)
- 6: Type of temperature displayed
a) Water temperature
b) Outside temperature
c) Room temperature (if RF room thermostat connected)
- 7: Program graphic of the current day
☉ Comfort temperature
☾ Reduced temperature
- 8: Pump indicator
- 9: Mixing valve activity indicator
▲ Valve actuator is opening
▼ Valve actuator is closing
- 10: Current day of the week (1 = Monday; 7 = Sunday)
- 11: RF reception indicator (optional).
- 12: a) Symbol temperature indication in °C / °F
b) Symbol AM / PM if 12 h mode
- 13: a) Outside temperature (°C / °F)
b) Time (12 h / 24 h)

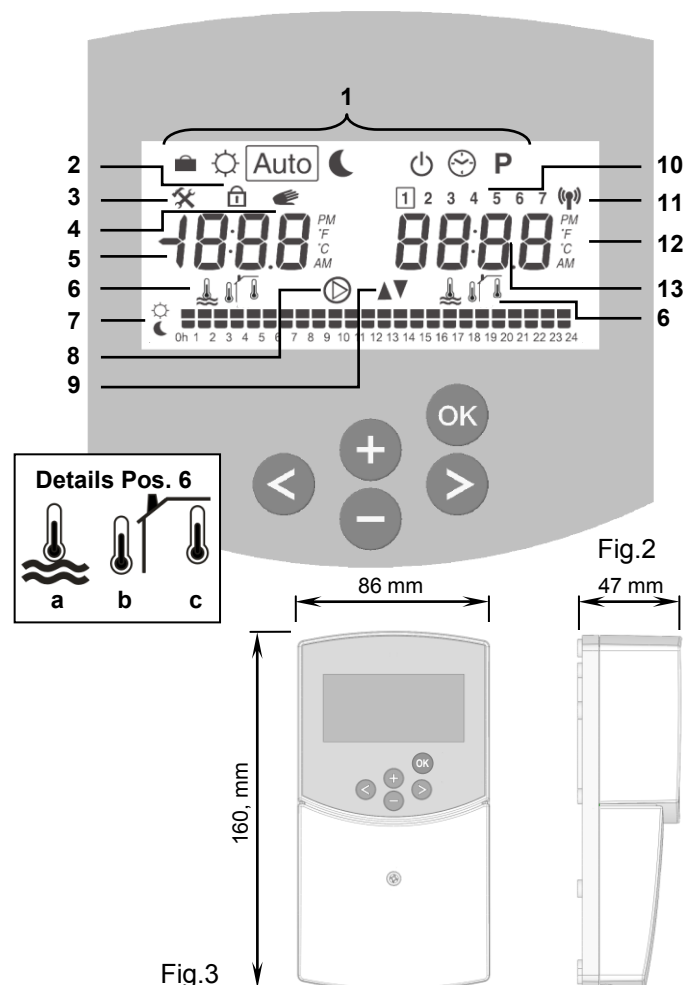

5. INSTALLATION AND ELECTRIC CONNECTIONS

5.1. CONTROLLER INSTALLATION

The Heating Controller can be installed directly on a solid base (e.g. a wall). For this purpose the front panel of the Controller must be removed (fig. 4a) and the back section should be fastened using appropriate screws and pins (these are not included in the scope of supply) (fig. 4b). Using a knife, remove the protection film before inserting the upper fastening screw.

If the Controller has been factory fitted with cables for connecting to a pump, valve drive, temperature limiter, sensors etc., take care not to damage or crack the cables during the installation. Furthermore these cables should not be subjected to any tensile stress during installation. The cables will be fixed by means of the device for strain relief at the heating controller.

If the Heating Controller is delivered together with a hydraulic control unit (for example FRG or FlowBox) and if it is not attached to that unit by any installation plate or support, it should be installed next to that unit.

Pay attention to the correct connection of the cables if the Controller is not installed directly on a hydraulic control unit but at some other place for the reason of better access. Refer to the directions about this in section 5.2 Electric connections.

After making the electric connections, refit the front panel. (fig. 4c).

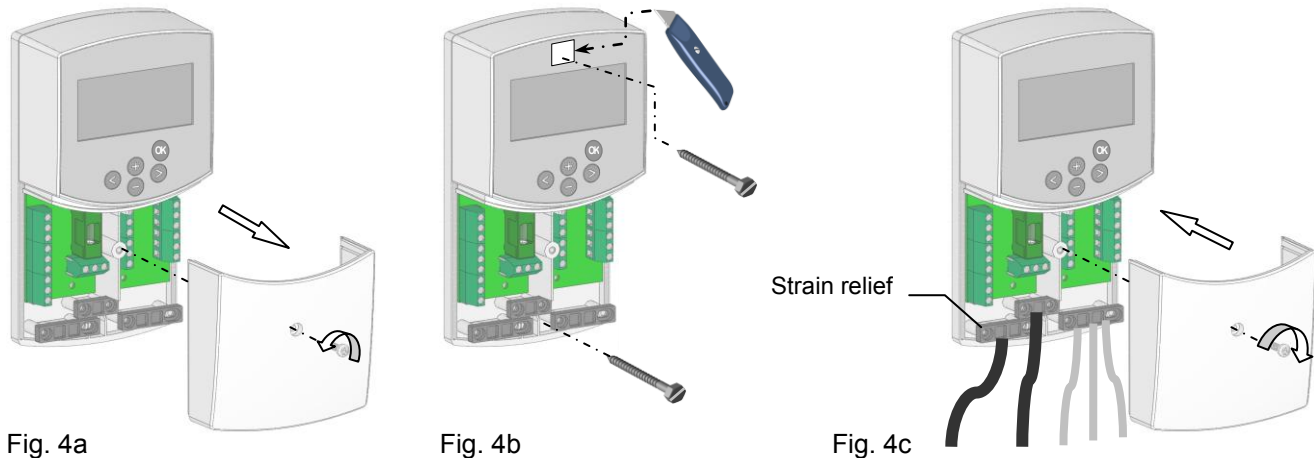

5.2. ELECTRIC CONNECTIONS

All electric connections must be made by an authorized specialist according to the local regulations on electric installations. The electrical cables must not come into contact with any hot components.

Optional connection – temperature limiter TB (option).

The connection is factory fitted with a cable bridge. It must be removed if connecting TB.

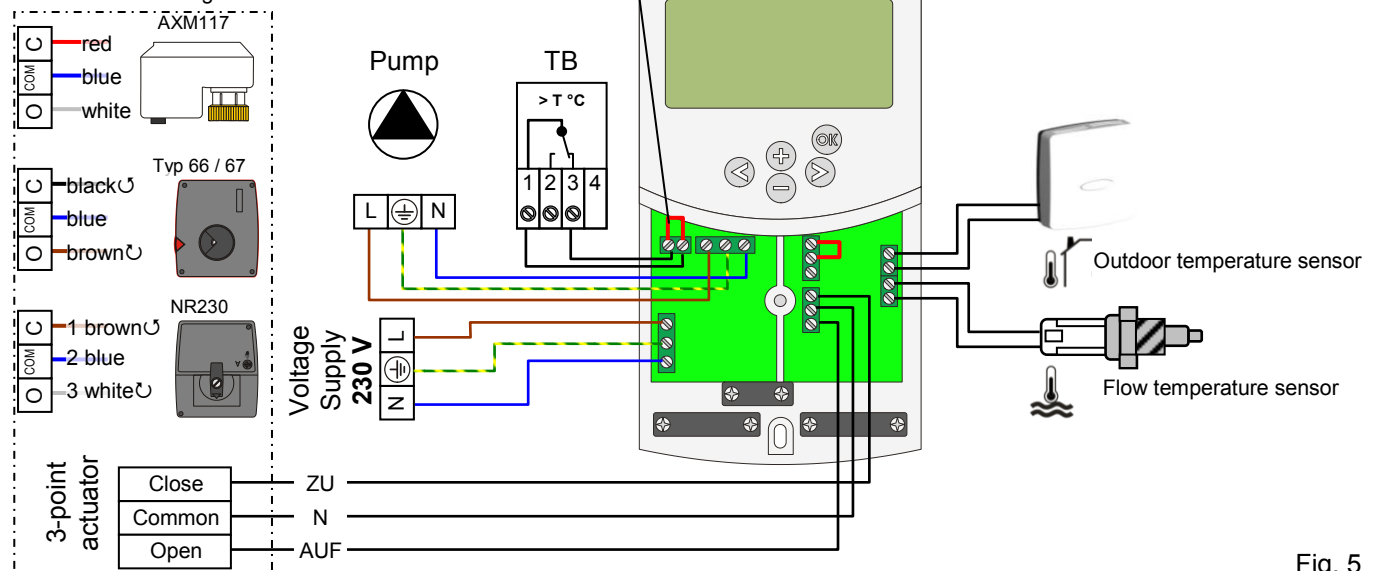

Fig. 5

5.3. ROOM TEMPERATURE – DIRECT PLUG IN

As an option you can plug in a room thermostat to the controller. Direct plug in of a room thermostat optimizes the operational time of the circulation pump and even the supply flow temperature depending on the conditions in the main room.

5.3.1. Standard room thermostat, wired type

If a wired type of a standard room thermostat is plugged in and the preset room temperature is reached the circulation pump switches off.

If no room thermostat is connected (the cable bridge is left in place), then the circulation pump switches off if within 30 minutes the controller has not initiated any change in the flow temperature.

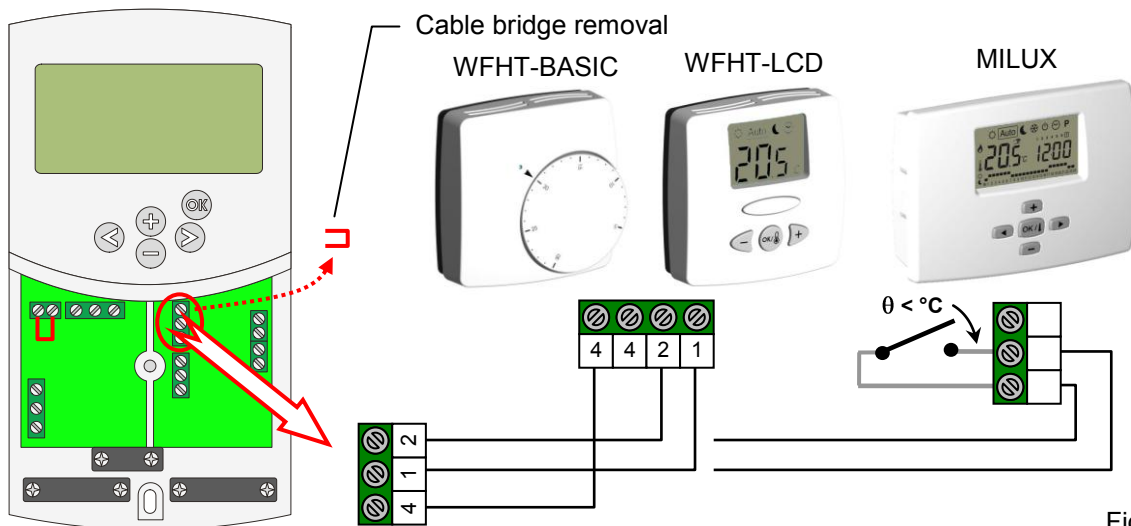

Fig. 6

5.3.2. RF room thermostat

If a radio frequency room thermostat is plugged in, the flow temperature calculated on the basis of outdoor temperature and the heating curve (= flow temperature preset value) is optimized depending on the main room temperature. The offset value is calculated in the following way:

Adjustment = preset value of supplied temperature + (room temperature - actual value) x offset
 (offset: → **System parameters**: value for adjustment of flow temperature)

Example 1: preset value of flow temperature = 35 °C; room temperature: preset value = 21 °C, actual value = 19 °C; offset = 1,5

Estimation 1: 35 °C + (21 °C – 19 °C) × 1,5 K >> flow temperature increased by 3,0 K to 38 °C

Example 2: preset value of flow temperature = 35 °C; room temperature: preset value = 21 °C, actual value = 22 °C; offset = 1,5

Estimation 2: 35 °C + (21 °C – 22 °C) × 1,5 K >> flow temperature decreased by 1,5 K to 33,5 °C

⚠ Radio alarm: If the Controller is activated by the RF thermostat and there is no transmission of radio signals for more than 2 hours, an alarm will be activated.

7. To stop the alarm, keep the **(OK)** button pressed for about 10 seconds.
8. Check the batteries of the RF thermostat. Please replace them if exhausted.
9. Check the position in which the antenna was installed. It must be installed in vertical position. Installation in or on a metal body can abate the power of radio transmission. Minimize the distance to the RF thermostat.

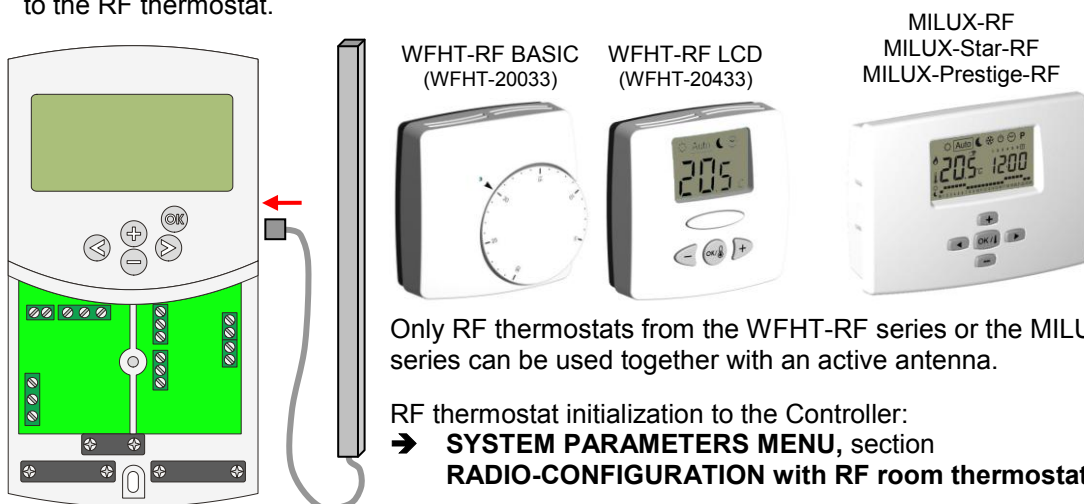

Only RF thermostats from the WFHT-RF series or the MILUX-RF series can be used together with an active antenna.

RF thermostat initialization to the Controller:
 → **SYSTEM PARAMETERS MENU**, section **RADIO-CONFIGURATION with RF room thermostat**

fig.7

6. TYPES OF OPERATING MODES / PROGRAM MENU

6.3 TYPES OF OPERATING MODES

Selection of the operating mode is done using the arrow keys (◀) and (▶). The cursor must be positioned on the symbol of the relevant operating mode.



NORMAL mode of operation

Unlimited operation in NORMAL mode .

The system runs in constant heating mode. The Heating Controller adjusts the flow temperature depending on the outdoor temperature and the selected heating curve. No temperature setback.

The display Pos. **5** shows the current flow temperature and the outside temperature at **13** (damped value). By pressing the button (**OK**) the preset value of flow temperature appears for about 3 seconds at **5**. At the same time the manually selectable deviation is displayed at **13** (factory setup: 00.0 = no deviation). Using the buttons (+) or (-) you can adjust the preset value of the flow temperature. If changed, the symbol  appears on the display.

In heating mode of operation the circulation pump is running continuously. The pump switches off if the preset value of the flow temperature is exceeded for 30 minutes. That is the case when the room heating is sufficient and the room thermostat closes all heating circuits by means of actuators. The same happens when the value of flow temperature calculated by the Controller becomes lower than the actual temperature value because of rising outdoor temperatures. If the actual value of the flow temperature falls below the preset value, the pump starts.

 To ensure energy saving operating mode of the pump it could be switched by a “pump logic” of a electric connecting box. The connecting box is normally used together with room thermostats and electrothermic actuators. The “pump logic” is a potential free switching relay, the contact of which is closed whenever higher temperature is demanded in any of the rooms. If all rooms are warm enough, the contact opens and the pump turns off.

 If the heat generator / boiler (WE) is in temperature setback and the temperature supplied by the WE is below the preset temperature calculated by the Controller, heating mode is not available. However if the circulation pump is actually running and the 2/3-way valve may also be opened by the 3-point actuator because of room heating demand, the preset value of flow temperature may be exceeded for a short period of time when the WE switches to heating mode. In this case, if a temperature limiter is available, the pump might switch off and then pump operation will be possible only after the temperature drops below the preset maximum temperature of the TB.

Trouble-shooting: The TB should be installed at a greater distance from the control unit. If necessary you can set the TB to a higher temperature until the pump starts. After a few minutes of pump operation the maximum allowable temperature set on the TB should be restored. Alternatively you can remove the TB from the pipe for a while and leave the pump running for a few minutes. Then refit the TB again to the pipe.



AUTOMATIC mode of operation

Automatic mode of operation using the built-in or user programs.

The heating system is controlled according to the selected built-in or user program (→ 6.2.).

If the system is in heating mode, the flow temperature is controlled depending on the outdoor temperature and the heating curve.

→ For the operation of the circulation pump please refer to the section of **NORMAL mode of operation**.



REDUCED TEMPERATURE mode of operation

Unlimited operation in REDUCED TEMPERATURE mode .

This is a constant mode of operation of the system. The heating Controller adjusts the flow temperature continuously on the basis of outdoor temperature and the selected heating curve and deducting the value of temperature setback (factory setting -10.0 K).

The display indicates the current flow temperature at **5** and the outside temperature at **13**. By pressing the button (**OK**) the preset value for the supply flow temperature reduced by the setback in temperature is displayed at **5** for 3 seconds. Simultaneously the reducing difference appears in **13** (without deviation = -10.0). It can be changed by the buttons (+) or (-).



→ For the operation of the circulation pump please refer to the section of **NORMAL mode of operation**.





ABSENCE/VACATION mode of operation



Time-limited operation of REDUCED TEMPERTURE mode .

Duration can be set between 1 and 24 hours and up to a maximum of 44 days. Upon expiration of this period the Controller switches over to operating mode Auto.

By means of the arrow keys (◀) the cursor is first moved to . Then  appears on the display at 13.

The duration of absence can be changed using buttons (+) or (-).

Example:  1 H = 1 hour;  1 d = 1 day

Both symbols  and  start blinking. The remaining time is displayed at 13.

To discontinue this mode of operation before time you have to set the remaining time at 13 to  using the (-) key.



STOP mode

This mode is used to switch off the system.

The device switches off the system. The Controller software version is indicated on the display for about 3 seconds and then switches off (no indications).

By pressing any of the keys the Controller can be switched on.

⚠ ATTENTION: When the Controller is switched off the heating system could freeze!

6.4 PROGRAM MENUS

By means of the arrow keys (◀) and (▶) you scroll through the program menus. The cursor should be positioned on the symbol you wish to select.



TIME AND DATE Program menu – setting

In this menu you can set the actual time and date as well as the day of the week.

Using the cursor select  first and then press the (OK) key.

By keys (+) or (-) set the minutes; confirm by pressing (OK).

08:23

By keys (+) or (-) set the hour; confirm by pressing (OK).

08:23



By keys (+) or (-) set the day of the week; press (OK) to confirm.

1 2 3 4
1 1





PROGRAMMING menu

In this menu you choose the program of the Controller (duration of the periods for operation in reduced temperature and heating mode), which is to be followed in operating mode Auto. You can choose between factory set programs from P1 to P9 (→ 6.2.1.) and one of the user's programs from U1 to U4.

First you select  with the help of the cursor. The indication  appears at 5. Press the (OK) key and the indication  starts blinking. By the keys (+) or (-) now you can select the program you need and confirm it by pressing (OK).

User-defined Programs (U1 – U4)

If you choose one of the user programs from U1 to U4, you can program the REDUCED temperature and NORMAL heating times directly. Proceed as follows:

At 13 the time indication blinks and day 1 is highlighted, while at 7 the time cursor blinks at 0 h on the symbol  (heating mode). Pressing the (-) key you can move the time cursor to the  symbol (REDUCED temperature mode). Then the time cursor jumps to the next hour. Thus NORMAL and REDUCED temperature cycles are selected using the (+) and (-) keys.

Using arrow keys (◀) and (▶) you can select the time in the same manner.

When day 1 programming is completed the time cursor switches automatically to 0:00h of day 2. Thereby the programmed values for day 1 are stored. Programming other days is done using identical procedure moving the cursor by pressing (▶). When you switch over to programming the next day the program for the previous day is saved. On completing the programming of the last day 7, the indication first switches to

the program menu **P**, and in about 15 seconds back to **Auto**.
 If during programming no inputs are made within 20 seconds, indication switches first to the program menu **P**, and in another 15 seconds it returns to **Auto**. The inputs were not stored.

Factory / built-in programs (P1 – P9)

If you select any of the factory programs from P1 to P9, you confirm it by pressing the key **(OK)**. Then pressing the arrow key **(◀)** scroll back to the menu for selecting an operation mode (if the arrow key is not pressed in about 15 seconds the display turns back to operating mode **Auto**).

6.4.1 Factory set NORMAL & REDUCED temperature times in programs P1 - P9

- P1:** Morning, Evening & Week-end
- P2:** Morning, Midday, Evening & Week-end
- P3:** Day & Week-end
- P4:** Evening & Week-end
- P5:** Morning, Evening (bathroom)
- P6:** Morning, Afternoon & Week-end
- P7:** 7h - 19h (Office)
- P8:** 8h – 19h , Saturday (Shop)
- P9:** Week-end (Secondary House)

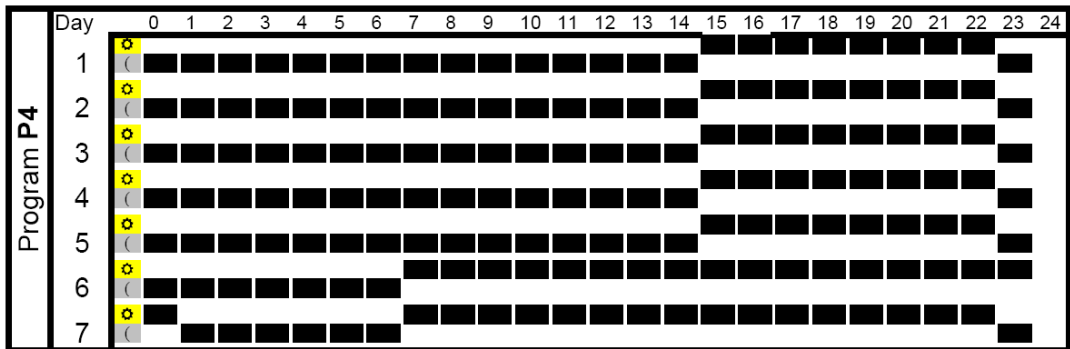
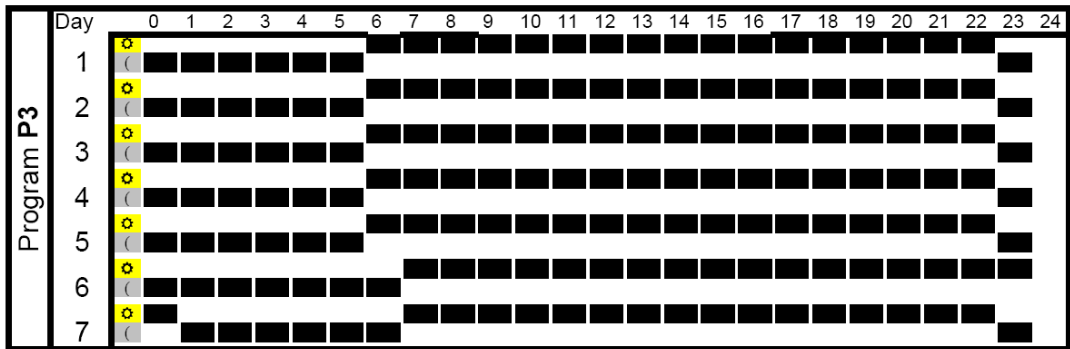
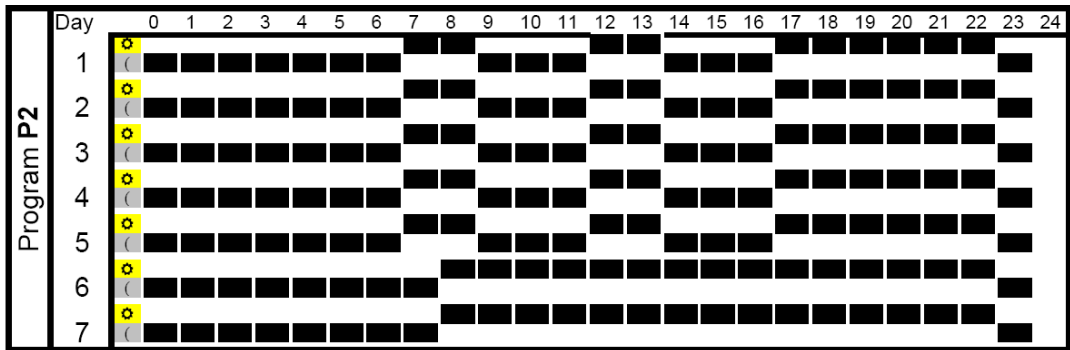
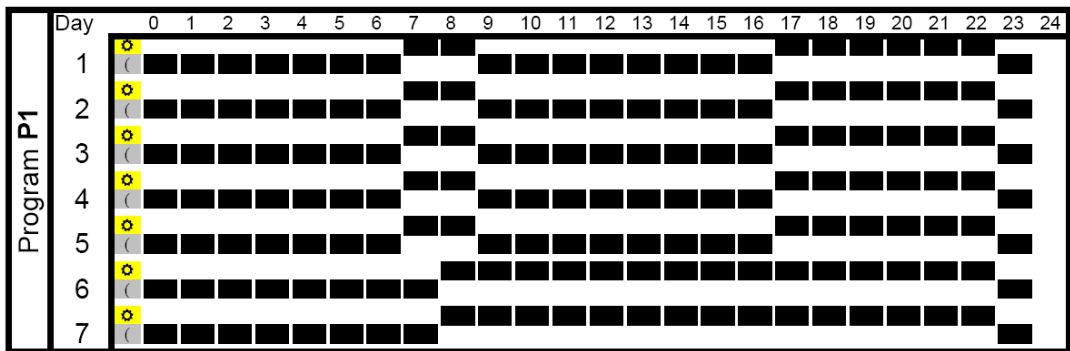

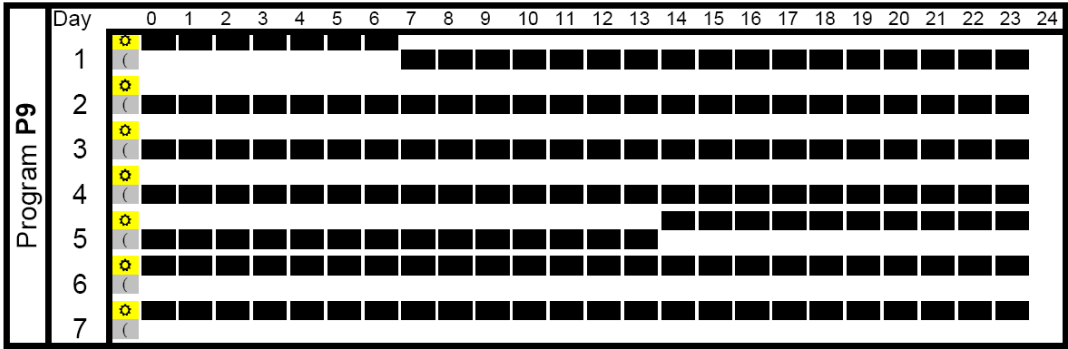
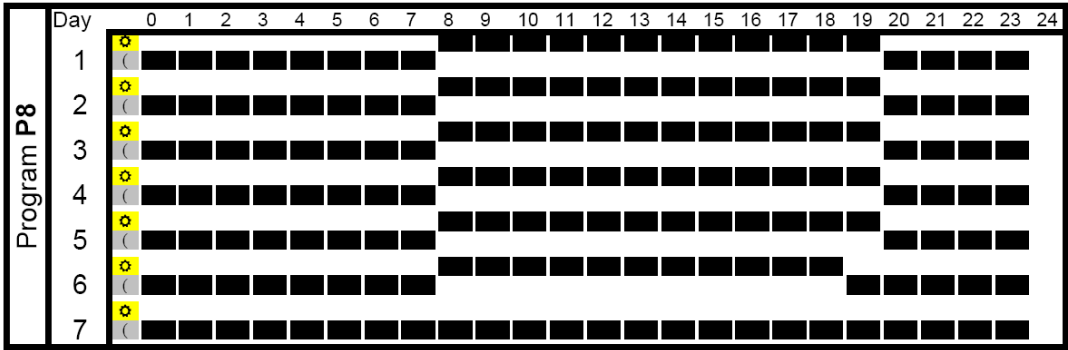
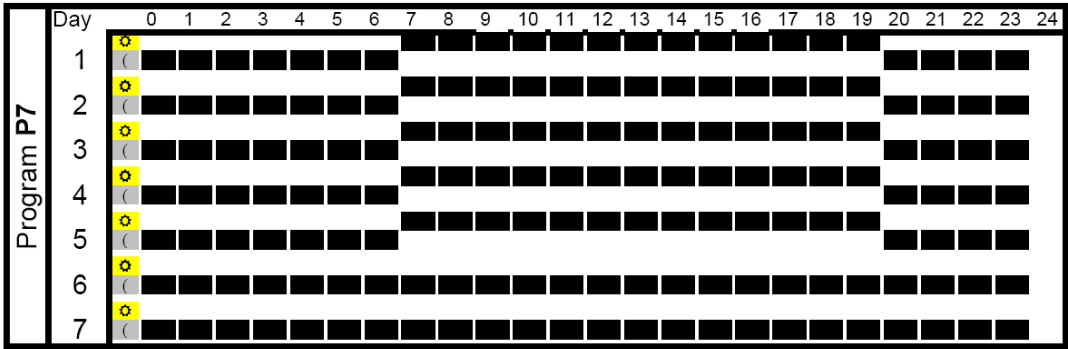
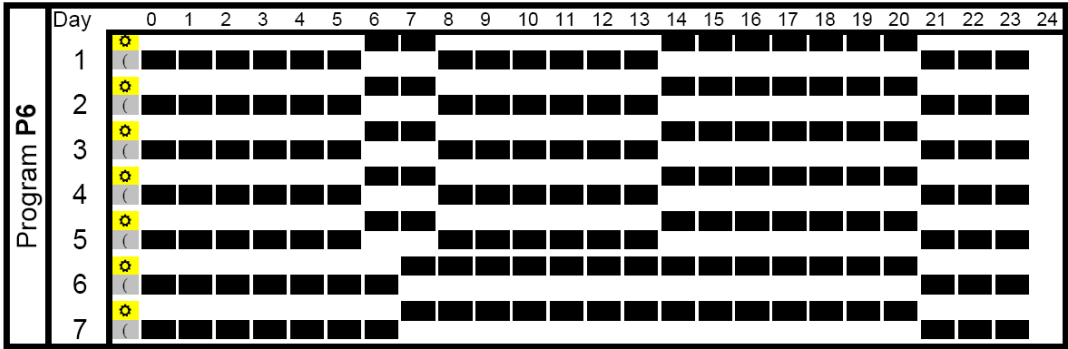
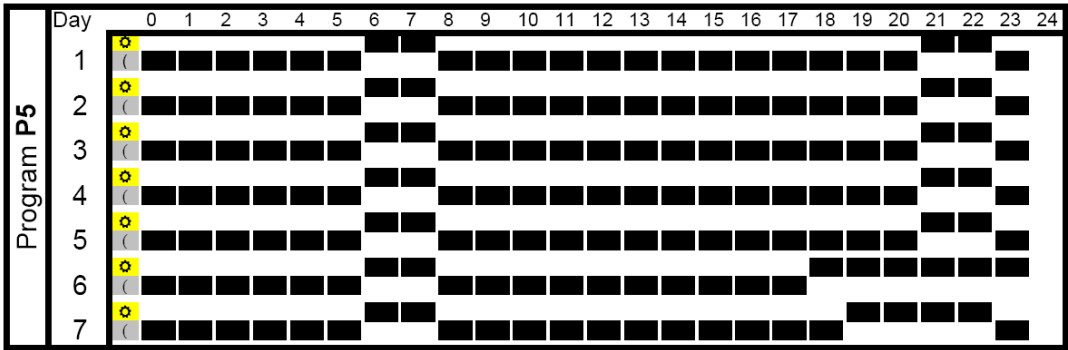

⚠ The Controller operates only in Auto mode according to the selected NORMAL and REDUCED temperature periods. During NORMAL periods (⊗) the flow temperature is controlled on the basis of the chosen heating curve and the actual outdoor temperature.

7. SYSTEM PARAMETERS MENU

7.1 SYSTEM PARAMETERS SETTING

This menu is used to set the most important parameters for the operation of the heating system.

To access this menu scroll with the cursor to . Then keep the (◀) key pressed for 10 seconds. The display shows as well as the preset heating curve (for example 0.7 Cur).

Parameters are selected by pressing the (+) or (-) keys.

To change the parameters press (OK) and using (+) or (-) change them or switch them over by pressing (OK).

To leave the menu press the (▶) key. The cursor changes to and then to after about 10 seconds.

| SYSTEM PARAMETERS | | | | |
|-------------------|---|----------------------|--|--------------|
| Values | Parameters description | Factory setting | Alternative setting | User setting |
| 0.7 Cur | Heating curve (see fig. 7) | 0.7 | 0 to 5 | |
| 50.0 °C Hi | Maximum value of flow temperature | 50 °C | 15 – 100 °C | |
| 10.0 °C Lo | Minimum value of flow temperature | 10 °C | 0 – max. 1 K below max. supply temperature | |
| 1888 °C | Temperature indication in °C or °F | °C | °F | |
| 24h 8888 | Time indication mode 24 hours or 12 hours | 24 h | 12 h | |
| YES Or P | Side-track protection When YES is highlighted the pump and the auxiliary actuator are activated for 2 minutes at 12 hrs midday, if they haven't been active for a period of 24 hours. | YES (active) | NO (inactive) | |
| NO Inth | Type of the room thermostat. A thermostat can be connected to the Controller for temperature control in one principal room. | NO (normally opened) | NC (normally closed) | |
| 0 dry | Floor / screed preheating program. The program is started by selecting „7 dry“ and runs automatically. The number of the days until the end of the heating program is displayed. For a period of 3 days the flow temperature is kept at 25 °C (days 7, 6, 5). For next 4 days the flow temperature is maintained at its preset maximum value (days 4, 3, 2, 1). | 0 dry | 7 dry | |
| 10 thof | Value for adjustment of the flow temperature Functional only if RF thermostat is available! The flow temperature is adjusted by this value depending on the room temperature (→ 5.3.2). | | | |
| no thrf | RADIO-CONFIGURATION with RF thermostat for room temperature 11. Press the (OK) key. Using the (+) or (-) keys to set the Controller into rf init mode. „INI thrF“ appears on the display. 12. Set the RF thermostat into rf init mode (→ MuB). 13. If successful rf initialisation the RF thermostat sends a radio signal to the Controller. The actual value of room temperature appears flashing on the display instead of "INI". 14. The process is completed by pressing the (OK) key of the Controller. 15. Exit the rf init mode of the RF thermostat. (→ MuB). Selecting „no thrF“ disconnects the RF thermostat from the Controller and discontinues the room temperature plug-in function respectively. ⚠ Connection of room thermostats is only possible using appropriate devices. | | | |
| no ourf | RADIO-CONFIGURATION with RF sensor for outdoor temperature The procedure is the same as that for RADIO-CONFIGURATION with RF thermostat for room temperature. | | | |
| Act ctrl | Manual mode (or test function) for valve drive respectively 2/3-way valve By pressing the (+) key the valve drive opens. The display shows „OPEN“ and ▲. By pressing the (-) key the valve drive closes. The display shows „CLOSE“ and ▼. By pressing the (OK) key the current position of the valve drive is kept. ⚠ There is a resultant time offset of 15 seconds between the switching over from „OPEN“ to „CLOSE“ and vice versa. | | | |
| Clr ALL | Reset function By keeping the (OK) key pressed for about 5 seconds all system parameters, time and day of the week as well as user programs in are reset to the factory setting. Established radio configuration to rf thermostats, if any, is also erased. The cursor moves to . | | | |

7.2 HEATING CURVES

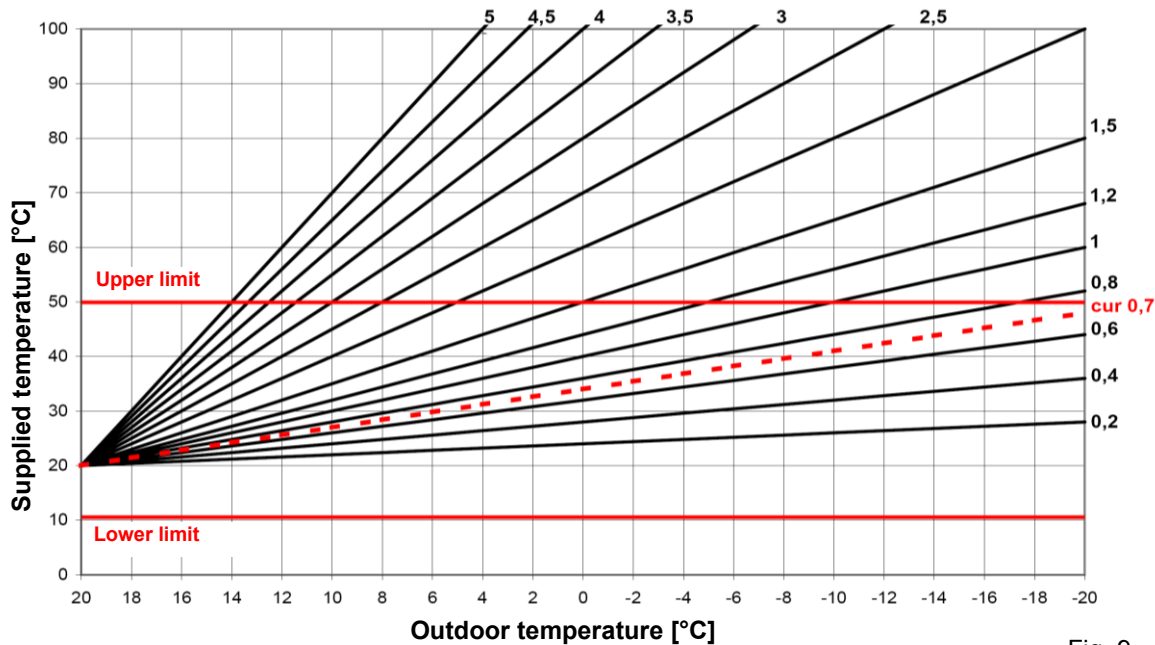



Fig. 9

8. TECHNICAL DATA / MATERIALS

| | |
|---------------------------------|---|
| Measured temperature accuracy: | 0,1 °C |
| Operating temperature: | 0 - 50 °C |
| Flow temperature control range: | 0 - 100 °C |
| Regulation characteristics: | Non-linear PID control Intelligent 3-point control (automatic detection of operating point) |
| Electrical protection: | Class II – IP 30 |
| Supply voltage: | 230 V (±10%), 50 Hz |
| Outputs: | <u>pump:</u> 5 A / 250 V relay (L, N, PE) <u>3-point control:</u> 2 TRIACS => 75 W max. |
| Sensor: | <u>outside temperature:</u> CTN 10 KΩ at 25 °C (class II, IP55) <u>supplied temperature:</u> CTN 10 KΩ at 25 °C (class I, IP68, no coupling) |
| Software version: | _. _ (displayed when switched off – STOP  mode). |

9. TROUBLE-SHOOTING

| X. | TROUBLE | |
|-----------|--|---|
| X.X | Possible reason | Elimination |
| 1. | The display shows E_{rr} | |
| 1.1 | E_{rr} at 13 Disconnected outside temperature sensor | Check whether the connection of sensor cable is correct. Check the cable for damages. Replace the cable or the sensor, if necessary. |
| 1.2 | E_{rr} at 5 Disconnected flow temperature sensor | Check whether the connection of sensor cable is correct. Check the cable for damages. Replace the cable or the sensor.. |
| 2. | Incorrect flow temperature | |
| 2.1 | Too high flow temperature due to incorrectly connected valve drive (reverse action) | Check the connection of the valve drive (→ 5.2). |
| 2.2 | Too low flow temperature due to incorrectly connected valve drive (reverse action) | Check the connection of the valve drive (→ 5.2). |
| 2.3 | Incorrect selected operation mode | Select the correct mode of operation. |
| 2.4 | When Controller operating in AUTOMATIC mode: - incorrect programming of built-in or user program - incorrect setting of time / day of the week | - Check the factory program or the user program settings and pay attention to the correct setting of NORMAL and REDUCED temperature periods of operation. - Check the setting of the time / day of the week. |
| 3. | The pump or the valve drive does not work | |
| 3.1 | Cable connections reversed. | Check the electric connections (→ 5.2). |
| 3.2 | Pump connected to temperature limiter. | - Check the electric connection (→ 5.2). - Check the maximum temperature setting of the TB. - Check the ambient temperature of the TB. If necessary, change its position. - Check the TB operation. Replace it if necessary. |



www.watts-water.eu

CE