



# WATER FLOOR HEATING



Solution :

- Wired and Wireless version
- Heating and cooling
- Smart Home with remote control through internet

Better comfort  
&  
Energy saving

Help the world to reduce CO2 emission

## WATER FLOOR HEATING

Today *WATTS INDUSTRIES EUROPE* is one of the largest specialist supplier of components for warm water heating system. From a flowmeter to an electric actuator, from a manifold to a complete pump group, we can also offer a wide range of controls covering most of the customers demand.

We offer you a new range of BT regulation with several modules allowing to adapt itself to the several combinations which we can found on the field :

### Multiple possible configurations

- Wired/Wireless
- With / without programming for energy saving
- Mono (Air) / Dual sensor (Air + Floor)
- 24V or 230V Power supply for the connecting box
- Heating or Heating & Cooling
- Multiple zones
- Mix of heating solutions management

Watts has the solution to cater to your requirements using the BT Range new design portfolio.

The water floor heating and cooling is currently the best mode of diffusion. It is compatible with many choice of energy: Boiler, heat pump or solar panels. It is also one of the most economical to use because it works today in low temperature.

The regulation is a key element of the system as it has to manage both the coolant temperature and the ambient temperature needs for winter and summer. Moreover a regulation per zone and a mix of heating solution could be required.

Watts Industries Europe offers regulation solutions for heating and cooling, allowing a maximum user comfort, high energy efficiency, and an appropriate response to the need for renewable energy development.

### One Option

Our new WATTS central allows to control and monitor your accommodation with one simple click from everywhere you are. WIFI connectivity enables to manage your installation remotely.





**IMAGINE YOUR HOME**  
*with solutions that*  
**WATER UNDERFLOOR HEATING SYSTEMS**  
*will give you*



## HEATING APPLICATION (Wired Solution)

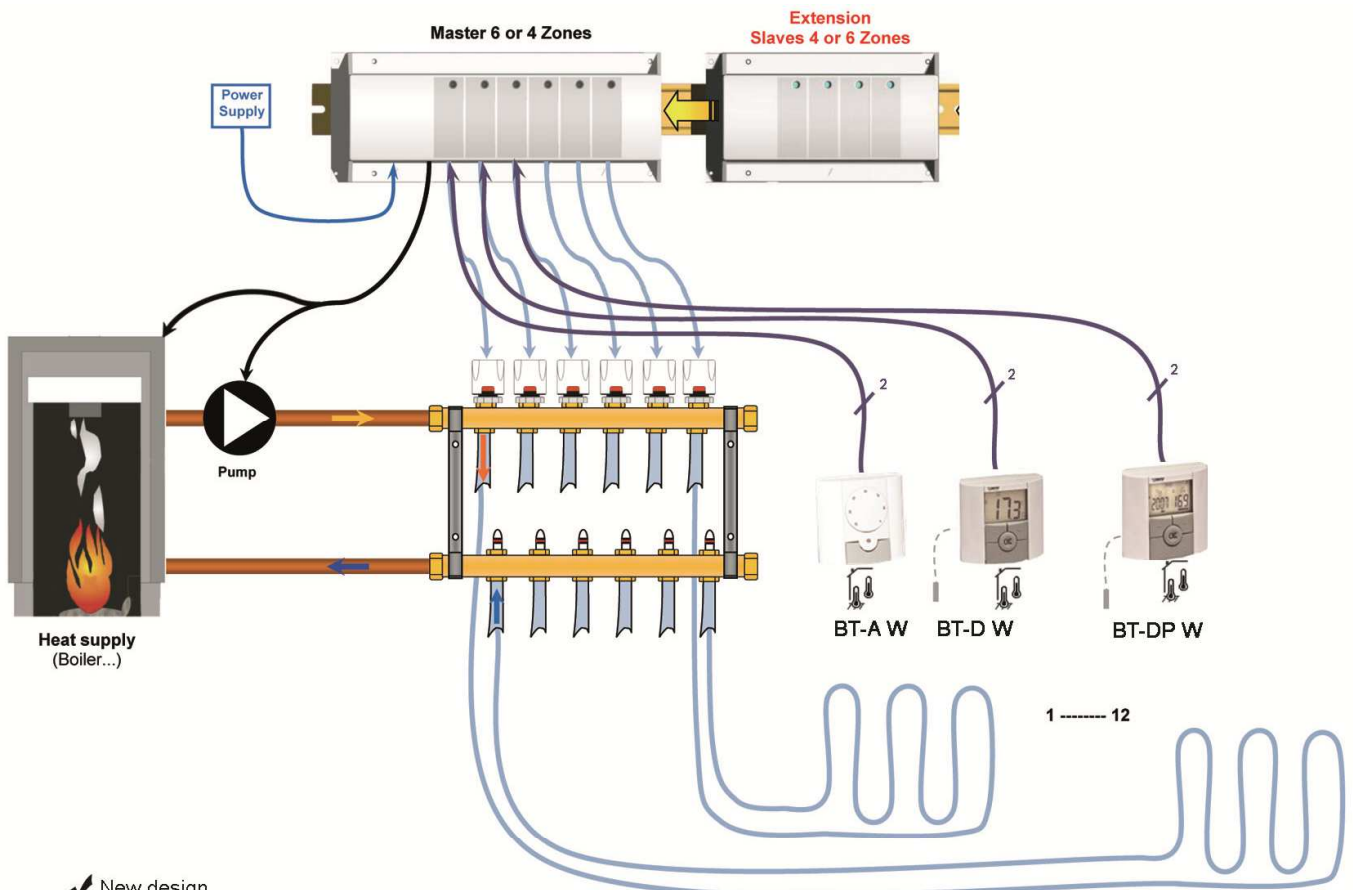

- ✓ New design
- ✓ 24V or 230V , 5A relay contact in thermostats
- ✓ Battery(AAA) powered thermostat
- ✓ Up to 12 zones
- ✓ All thermostats are dual sensors
- ✓ Electronic analog or digital thermostat
- ✓ Digital Thermostat programmable or not

# HEATING APPLICATION (Wireless Solution)

Up to 4 Floors

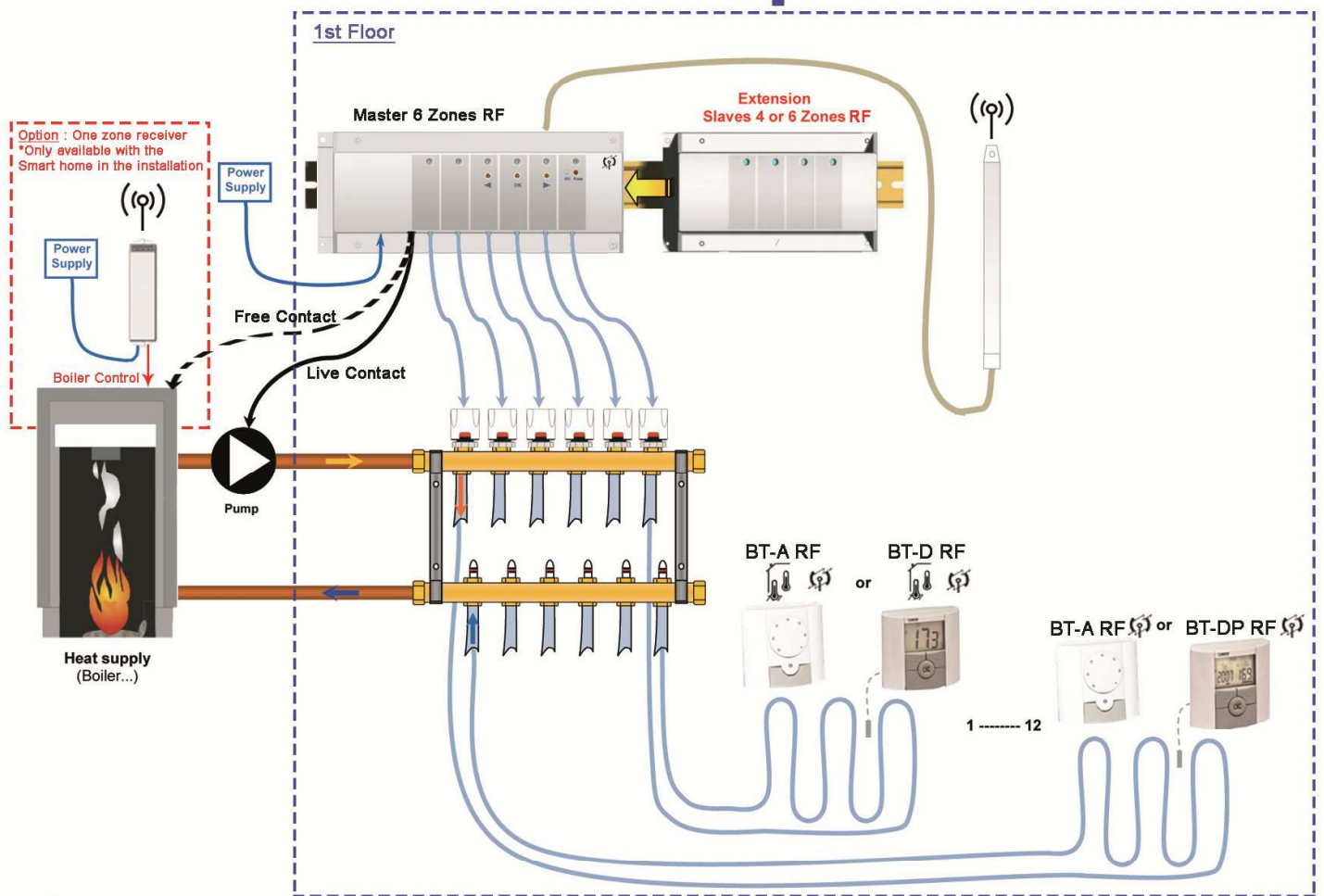

- ✓ New design, 868 MHz RF bidirectional
- ✓ Up to 12 zones per connecting boxes
- ✓ Multiples connecting boxes for multiple floors  
Each floor can trigger the heat supply through the master connecting box controlling the boiler and pump
- ✓ 24V or 230V power supply versions
- ✓ All thermostats are dual sensors
- ✓ Electronic or digital bi directional RF thermostat
- ✓ Smart Home (Option) to centralize the control



**SMART HOME (in Option)**  
Up to 48 Zones

## HEATING & COOLING APPLICATION (4 pipes) Wireless solution

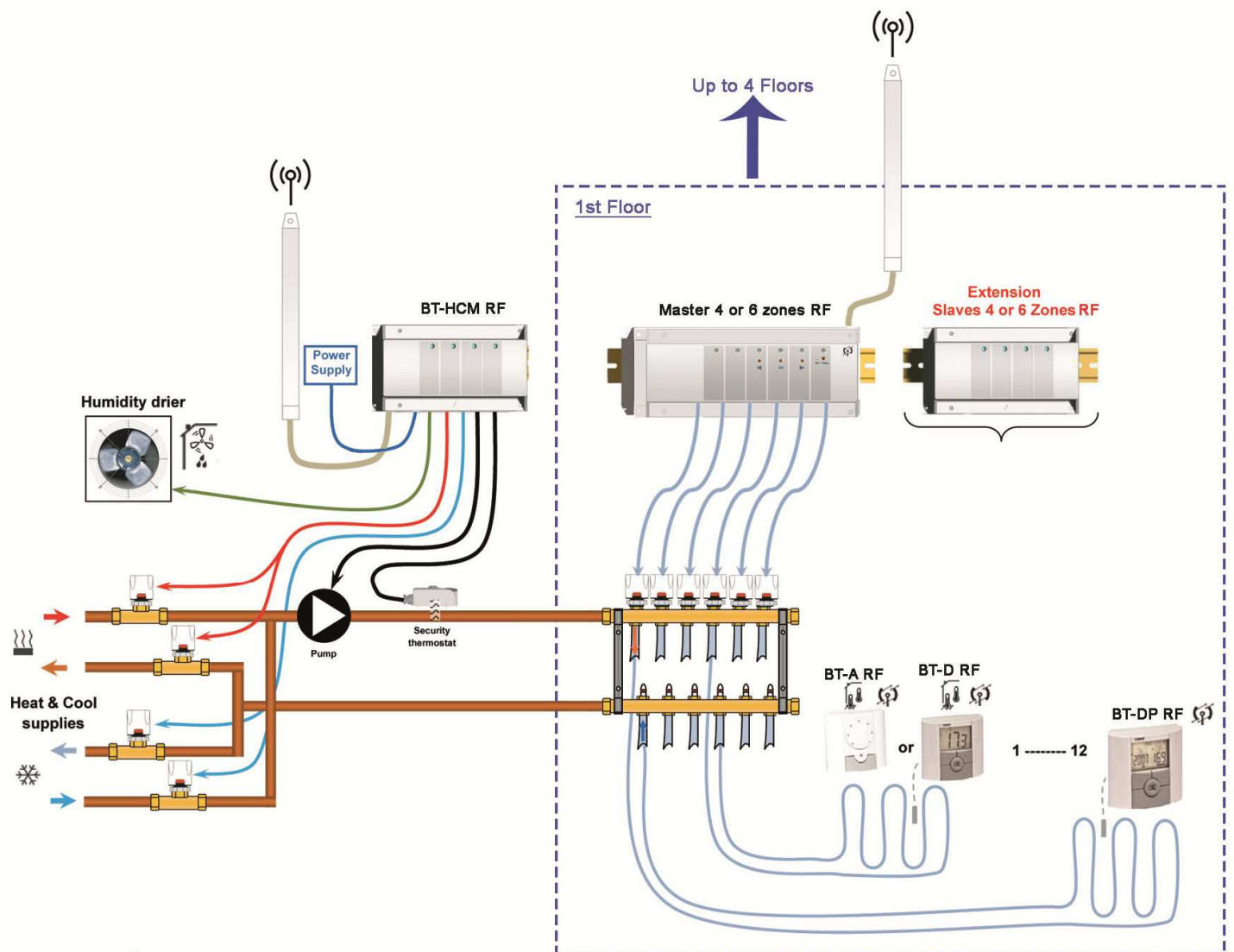

- ✓✓ New design, 868MHz RF
- ✓✓ Up to 12 zones per connecting boxes
- ✓✓ Multiples connecting boxes for multiple floors (Up to 4)  
1 box dedicated to control heating and cooling
- ✓✓ 1 RF heat /cool module to manage heat & cool and humidity
- ✓✓ All thermostats are dual sensor
- ✓✓ Electronic or digital bi directional RF thermostat
- ✓✓ Smart Home (Option) to centralize the control



**SMART HOME (in Option)**  
Up to 48 Zones







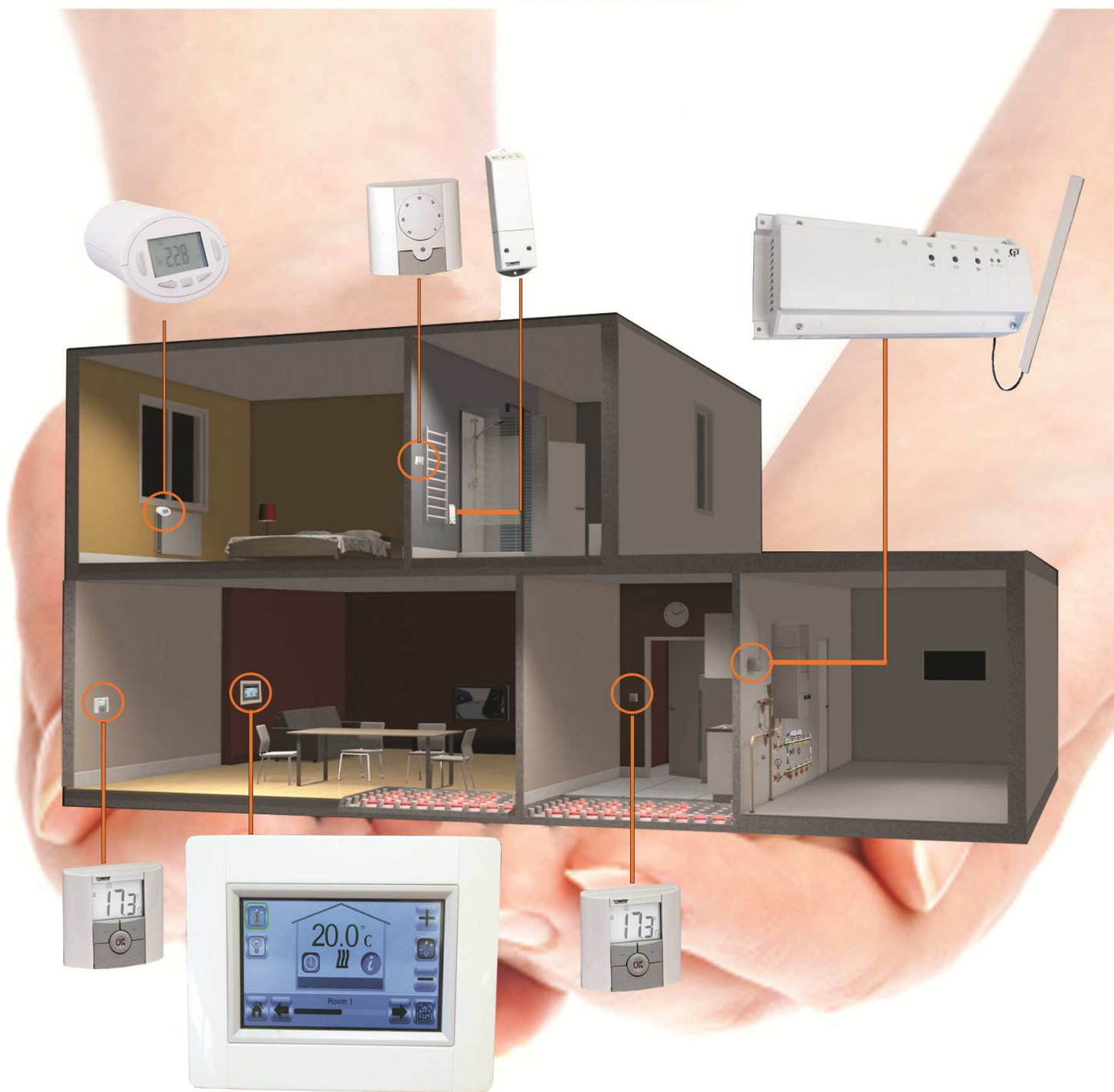



# COMPLETE

HOME SOLUTIONS

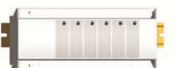













# WATER FLOOR HEATING APPLICATION "WIRED SOLUTION"

N°	Products	Application	NO or NC actuator	Program	Regulation	Power Supply	Power Rated	Outputs	Ext Sensor
BT-A W		Single Room Thermostat	NA	NO	PWM Air or wired sensor	2 AAA LR03 1.5V Alkaline	Up to 10 Actuators	1 for actuator	In Option
BT-D W		Single Room Thermostat	NA	NO	PWM Air or wired sensor or Air+Floor limit	2 AAA LR03 1.5V Alkaline	Up to 10 Actuators	1 for actuator	In Option
BT-DP W		Single Room Thermostat	NA	YES	PWM Air or wired sensor or Air+Floor limit	2 AAA LR03 1.5V Alkaline	Up to 10 Actuators	1 for actuator	In Option
WFHC MASTER 4 ZONES 24V		Connecting box	To be specified at order	NA	NA	24Vac in conjunction with the WFHC Transformer	Total number of actuator limited by size 60W transformer / Max actuator power	1 for Pump 4 for zones extendable to 10	NA
WFHC MASTER 6 ZONES 24V		Connecting box	To be specified at order	NA	NA	24Vac in conjunction with the WFHC Transformer	Total number of actuator limited by size 60W transformer / Max actuator power	1 for Pump 6 for zones extendable to 12	NA
WFHC SLAVE 4 ZONES 24V		Connecting box	To be specified at order	NA	NA	24Vac in conjunction with the WFHC Transformer	Total number of actuator limited by size 60W transformer / Max actuator power	Extension module 4 for zones	NA
WFHC SLAVE 6 ZONES 24V		Connecting box	To be specified at order	NA	NA	24Vac in conjunction with the WFHC Transformer	Total number of actuator limited by size 60W transformer / Max actuator power	Extension module 6 for zones	NA
WFHC MASTER 4 ZONES 230V		Connecting box	To be specified at order	NA	NA	230Vac	No limit	1 for Pump 4 for zones extendable to 12	NA
WFHC MASTER 6 ZONES 230V		Connecting box	To be specified at order	NA	NA	230Vac	No limit	1 for Pump 6 for zones extendable to 12	NA
WFHC SLAVE 4 ZONES 230V		Connecting box	To be specified at order	NA	NA	230Vac	No limit	Extension module 4 for zones	NA
WFHC SLAVE 6 ZONES 230V		Connecting box	To be specified at order	NA	NA	230Vac	No limit	Extension module 6 for zones	NA



# WATER FLOOR HEATING & COOLING APPLICATION "WIRELESS SOLUTION"

N°	Products	Application	Programme	Regulation	Power Supply	Outputs	Ext Sensor
BT-A02 RF		Single Room Thermostat RF Bidirectional 868 MHz	NO	NA	2 AAA LR03 1.5V Alkaline	NA	In Option
BT-D02 RF		Single Room Thermostat RF Bidirectional 868 MHz	NO	NA	2 AAA LR03 1.5V Alkaline	NA	In Option
BT-DP02 RF		Single Room Thermostat RF Bidirectional 868 MHz	YES	NA	2 AAA LR03 1.5V Alkaline	NA	In Option
RF MASTER 6 ZONES 24V		Connecting box	NO	PWM (by default) or in accordance with thermostat setting (PWM or hysteresis)	24Vac in conjunction with the WFHC Transformer	5A Relay *6 + 1 pump	NA
RF MASTER 4 ZONES 24V		Connecting box	NO	PWM (by default) or in accordance with thermostat setting (PWM or hysteresis)	24Vac in conjunction with the WFHC Transformer	5A Relay *4 + 1 pump	NA
RF SLAVE 6 ZONES 24V or 230V		Connecting box	NO	PWM (by default) or in accordance with thermostat setting (PWM or hysteresis)	230Vac or 24Vac in conjunction with the WFHC Transformer	5A Relay *6	NA
RF SLAVE 4 ZONES 24V or 230V		Connecting box	NO	PWM (by default) or in accordance with thermostat setting (PWM or hysteresis)	230Vac or 24Vac in conjunction with the WFHC Transformer	5A Relay *4	NA
RF MASTER 6 ZONES 230V		Connecting box	NO	PWM (by default) or in accordance with thermostat setting (PWM or hysteresis)	230Vac	5A Relay *6 + 1 pump	NA
RF MASTER 4 ZONES 230V		Connecting box	NO	PWM (by default) or in accordance with thermostat setting (PWM or hysteresis)	230Vac	5A Relay *4 + 1 pump	NA
BT HCM RF 230V		Connecting box	NO	NA	230Vac	16A Relay *4 for heating, cooling, humidity drier and pump	Water sensor for H&C switching
BT-WR		Wall receiver	NO	NA	230Vac	16A Relay	NA
BT-CT02 RF Wifi		Central	YES	NA	230Vac or USB	NA	NA

*Always  
in Touch  
With your*  
**Home Smart**

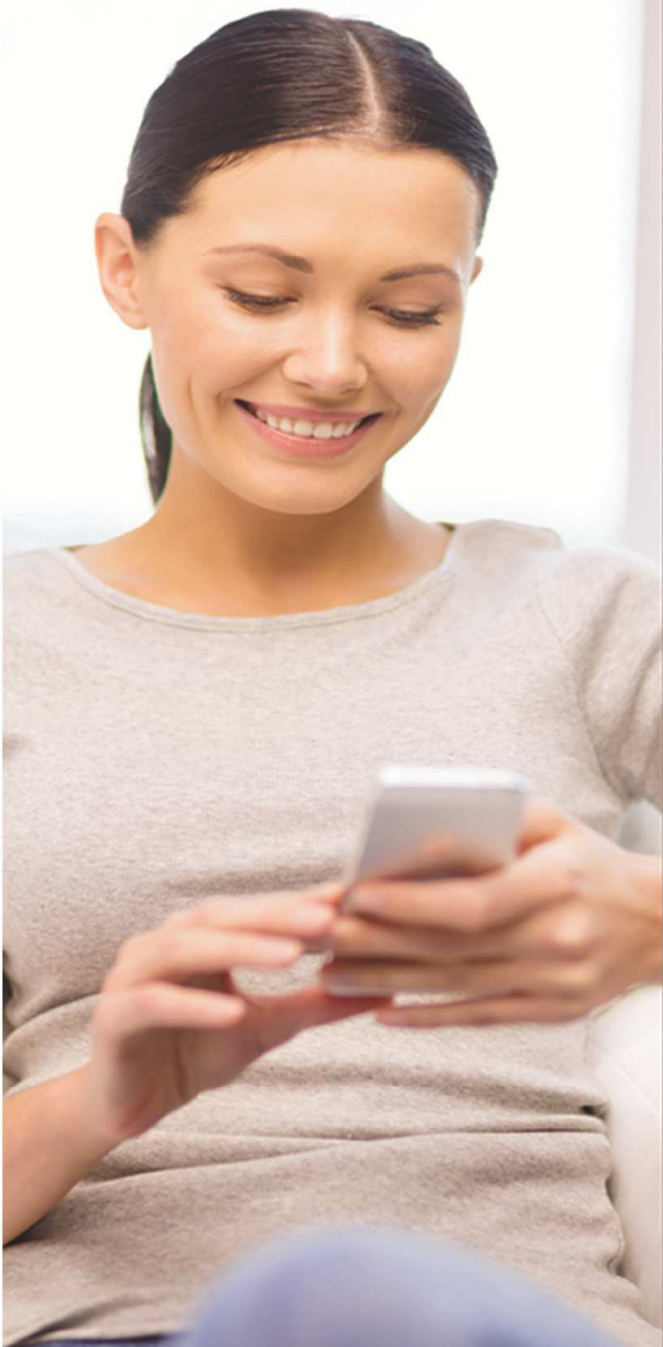

GSM Remote  
WEB Remote  
AIR Control

Electric & Hydraulic Energy Metering  
Electrical Floor Heating Control  
Electrical Panel Heater Control  
Heating /Cooling and Hydraulic Control  
Detectors Controls

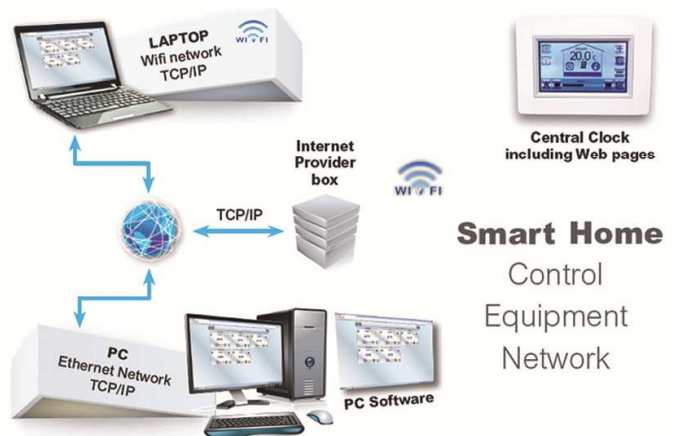



# A complete concept to control water and room temperature

*Watts Industries offers comprehensive solutions for manifold and control technology that perfectly match and adjust to your system.*



Manifold



Kit Climatic



Actuators



Thermometers



Airvents



Mini Ball



Flowmeters



Contacts



Fittings



## Technology by nature

### Product Range WATTS INDUSTRIES

- System disconnectors
- Backflow protection devices
- Check valves
  - Safety units
  - Safety relief valves
    - Pressure reducing valves
    - Automatic control valves
      - Butterfly valves
      - Shut off valves
      - Measuring gauges

- Temperature control
  - Expansion vessels
  - Process switches
    - Fuel products
    - Gas products
      - Electronics controls
    - Installation protection products
      - Radiator valves
      - System products
        - Manifolds and fittings



A Division of Watts Water Technologies Inc.

### Watts Electronics

ZA des Tourettes, 43800 ROSIERES, FRANCE

Phone +33 471 57 40 49 - Fax +33 471 57 40 90

E-mail: [sales@wattselectronics.com](mailto:sales@wattselectronics.com) - Site: [www.wattswater.fr](http://www.wattswater.fr)

