

130UM, 130SN, 131UM, 131SN, 1130UM, 1131UM Series

Thermostat-adaptable valves with pre-setting

Technical Data Sheet



Description

130UM, 130SN, 131UM, 131SN, 1130UM, and 1131UM Series thermostatic valves with pre-setting are used as shut-off and control devices for heat emitters (radiators, fan coils, radiant panels, etc.) in heating and air conditioning systems, in conjunction with **148, 148A, 148SD** and **148CD Series** thermostatic actuators. The valves are available in right-angle and straight configuration, with male or female thread, and must be installed on the heat emitter. They are connected by means of an O-Ring sealed straight tailpiece, using a hex wrench. The special feature of the O-Ring is that it ensures perfect external sealing whenever the valves are installed on radiators with GAS thread in place of other (manual) valves, for which there is a risk that the internal thread of the radiator cap may no longer conform.



130UM/130SN

Nickel-plated thermostatic valve equipped with pre-setting device. Right-angle body. Connection for iron pipe. Straight tailpiece with O-ring. Easily removable protective cap to allow installation of **148, 148A, 148SD** and **148CD Series** thermostatic actuators and **22C, 22CX, 22CX5** and **26LC Series** electrothermal actuators. UNI EN 215 certified, together with **148** and **148A Series** thermostatic actuators.

Type	Part No.	DN	Kvs	Weight (g)
130UM	130UMSN38	3/8"	2.05	190
130UM	130UMSN12	1/2"	2.6	240
130UM	130UMSN34	3/4"	3.3	370
130SN*	130SN38	3/8"	2.05	190
130SN*	130SN12	1/2"	2.6	240
130SN*	130SN34	3/4"	3.3	370

*SN Series with conical tailpiece



130UM/130SN + actuator

130UM/130SN thermostatic valve, UNI EN 215 certified, with **148** and **148A Series** actuator.

Type	DN	***q _{mN} (l/h)	Weight (g)
130UM + actuator	3/8"	220	245
130UM + actuator	1/2"	220	295
130UM + actuator	3/4"	240	425
130SN* + actuator	3/8"	220	245
130SN* + actuator	1/2"	220	295
130SN* + actuator	3/4"	240	425

*SN Series with conical tailpiece

***q_{mN} refers to the excluded pre-regulation condition



131UM/131SN

Nickel-plated thermostatic valve equipped with pre-setting device. Straight body. Connection for iron pipe. Straight tailpiece with O-ring. Easily removable protective cap to allow installation of **148, 148A, 148SD** and **148CD Series** thermostatic actuators and **22C, 22CX, 22CX5** and **26LC Series** electrothermal actuators. UNI EN 215 certified, together with **148** and **148A Series** thermostatic actuators.

Type	Part No.	DN	Kvs	Weight (g)
131UM	131UMSN38	3/8"	1.1	210
131UM	131UMSN12	1/2"	1.8	270
131UM	131UMSN34	3/4"	2.6	360
131SN*	131SN38	3/8"	1.1	210
131SN*	131SN12	1/2"	1.8	270
131SN*	131SN34	3/4"	2.6	360

*SN Series with conical tailpiece



131UM/131SN + actuator

131UM/131SN thermostatic valve with **148** and **148A Series** actuator.

Type	DN	***q _{mN} (l/h)	Weight (g)
131UM + actuator	3/8"	205	265
131UM + actuator	1/2"	225	325
131UM + actuator	3/4"	240	415
131SN* + actuator	3/8"	205	265
131SN* + actuator	1/2"	225	325
131SN* + actuator	3/4"	240	415

*SN Series with conical tailpiece

***q_{mN} refers to the excluded pre-regulation condition

1130UM



Nickel-plated thermostatic valve equipped with pre-setting device. Right-angle body 1/2" connection for copper or plastic pipe. Straight tailpiece with O-Ring. Easily removable protective cap to allow installation of **148, 148A, 148SD** and **148CD Series** thermostatic actuators and **22C, 22CX, 22CX5** and **26LC Series** electrothermal actuators.

Type	Part No.	DN Body	DN Pipe	Kv	Weight (g)
1130UM	1130UMSN38X	3/8"	1/2"	2.6	180
1130UM	1130UMSN12	1/2"	1/2"	2.6	220

1131UM



Nickel-plated thermostatic valve equipped with pre-setting device. Straight body. 1/2" connection for copper or plastic pipe. Straight tailpiece with O-Ring. Easily removable protective cap to allow installation of **148, 148A, 148SD** and **148CD Series** thermostatic actuators and **22C, 22CX, 22CX5** and **26LC Series** electrothermal actuators.

Type	Part No.	DN Body	DN Pipe	Kv	Weight (g)
1131UM	1131UMSN38X	3/8"	1/2"	1.8	200
1131UM	1131UMSN12	1/2"	1/2"	1.8	240

Technical/design features

Valve body	CW617N brass
Handwheel	Polypropylene
O-Ring	EPDM
Tailpiece	CW617N brass
Maximum admissible static pressure	10 bar
Maximum differential pressure	1,5 bar
Maximum temperature	110°C
Usable fluids	Water, including with glycol ≤ 50%

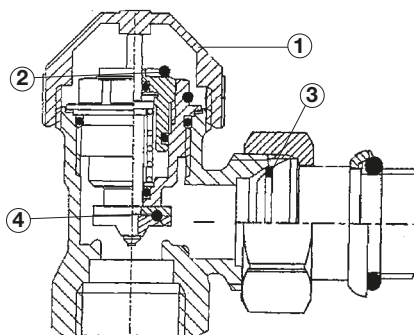



Features

- 1) Protective cap
- 2) Packing nut (stem sealing) which can be replaced without de-pressurising the system
- 3) Tailpiece with O-Ring heater side
- 4) Obturator gasket in elastomeric material, vulcanized ethylene-propylene (EPDM)
- 5) O-Ring valve side

The table below shows the nominal flow rates Q_{ms} (in the various valve body pre-setting positions) and the maximum flow rates q_{mN} of the CEN-certified valves with **148, 148A, 148SD** and **148CD Series** thermostatic actuators. As required by UNI EN 215, these values relate to a pressure differential $\Delta p = 10$ kPa. Using the formula set out below, it is therefore possible to calculate the maximum Kv for each pre-setting set-point of the valves.

$$Kv = \frac{q_m}{316}$$

	TYPE	Pre-setting q_{ms} l/h								Full opening q_{mN} l/h
		DN	SP1	SP2	SP3	SP4	SP5	SP6	SP7	
	130	3/8"	80	175	220	220	220	220	220	220
		1/2"	80	175	220	220	220	220	220	220
		3/4"	80	180	240	240	240	240	240	240
	131	3/8"	75	160	205	205	205	205	205	205
		1/2"	75	175	225	225	225	225	225	225
		3/4"	80	180	240	240	240	240	240	240
Tolleranza \pm %			60	30	20	10	10	10	10	10

*Value only q_{mN}

TYPE	DN	Authority (a)							Full opening
		Pre-setting							
		SP1	SP2	SP3	SP4	SP5	SP6	SP7	
130	3/8"	0,15	0,2	0,38	0,6	0,7	0,77	0,8	0,87
	1/2"	0,15	0,2	0,4	0,61	0,71	0,76	0,8	0,92
	3/4"	0,2	0,26	0,44	0,65	0,76	0,81	0,84	0,94
131	3/8"	0,2	0,2	0,32	0,5	0,55	0,58	0,6	0,65
	1/2"	0,2	0,27	0,37	0,58	0,7	0,75	0,79	0,84
	3/4"	0,15	0,2	0,36	0,61	0,74	0,81	0,84	0,91

*Fully open only value

N.B. Information and diagrams for valves combined with thermostatic head are available on: www.wattswater.eu

Application

Thermostat-adaptable valves are designed for manual room temperature control, or automatic room temperature control if used in conjunction with thermostatic actuators (**148, 148A, 148SD** and **148CD Series**) or electrothermal actuators (**22C, 22CX, 22CX5** and **26LC Series**). The use of thermostatic valves makes it possible to install metering systems (see section on measuring and metering systems) as required by Italian law 10/91. The valves are equipped with active-memory pre-setting, to allow precise balancing of the system when used with thermostatic or electrothermal actuators. To balance the system, turn the ring-nut located under the handwheel to limit the stroke of the disc. In particular, in the event of removal of the handwheel for thermostatic control of the system, the active-memory pre-setting permanently retains the set balance.

Operation

Valve operation is controlled by manual or automatic movement (by means of the protective cap or in conjunction with thermostatic/electrothermal actuators respectively) of the disc that shuts off the heat carrier fluid. The fluid flow rate and pressure drop of the valves can be determined from the flow curves. In thermostatic mode, however, they assume the characteristics of the device in question. The reliability of the **130UM, 130SN, 1130UM, 131UM 131SN** and **1131UM Series** thermostatic valve bodies is guaranteed by the fact that every single product is tested to ensure the outward pressure tightness of the valve body and its components, and the pressure tightness of the disc when it shuts off the flow.

Charts

The fluid flow rate and pressure drop of the valve/actuator combination can be determined from the flow curves. The nominal flow rate q_{mN} is as for -2K when the pre-setting device is fully open. The diagrams represents the proportional band -1K, -2K and MAX flow curves.

If you prefer to use an analytical method for determining the pressure drop Δp (kPa), where flow rate (l/h) and K_vn are known, use the following formula:

$$\Delta p = \left(\frac{0.01 \times q}{K_v} \right)^2$$

Determine the pressure drop of the 131UM +148 DN 3/8" thermostatic valve combination with a flow rate of 80 l/h.

$$\Delta p = \left(\frac{0.01 \times 80}{0.65} \right)^2 = 1.52 \text{ kPa}$$

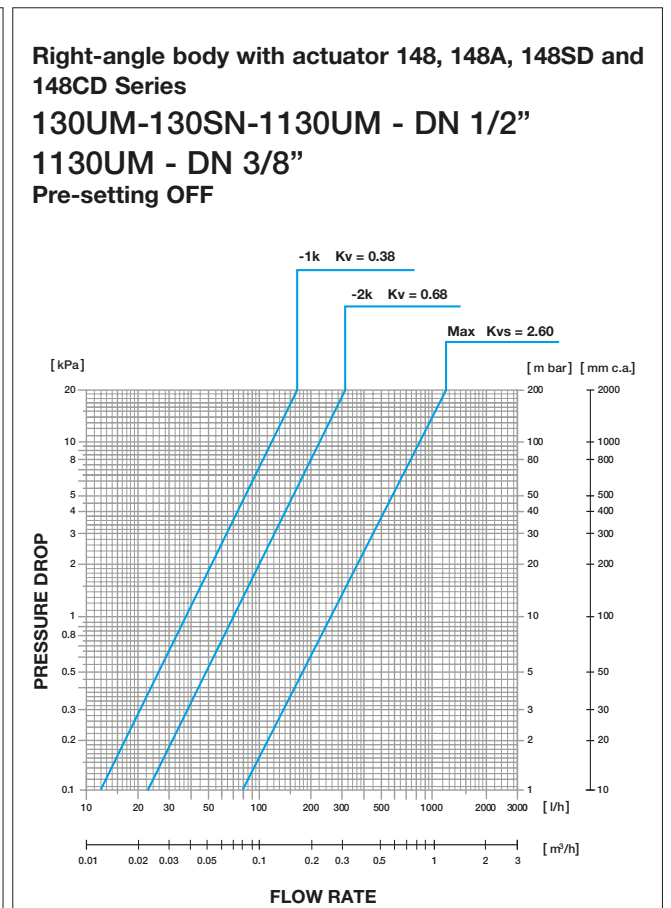
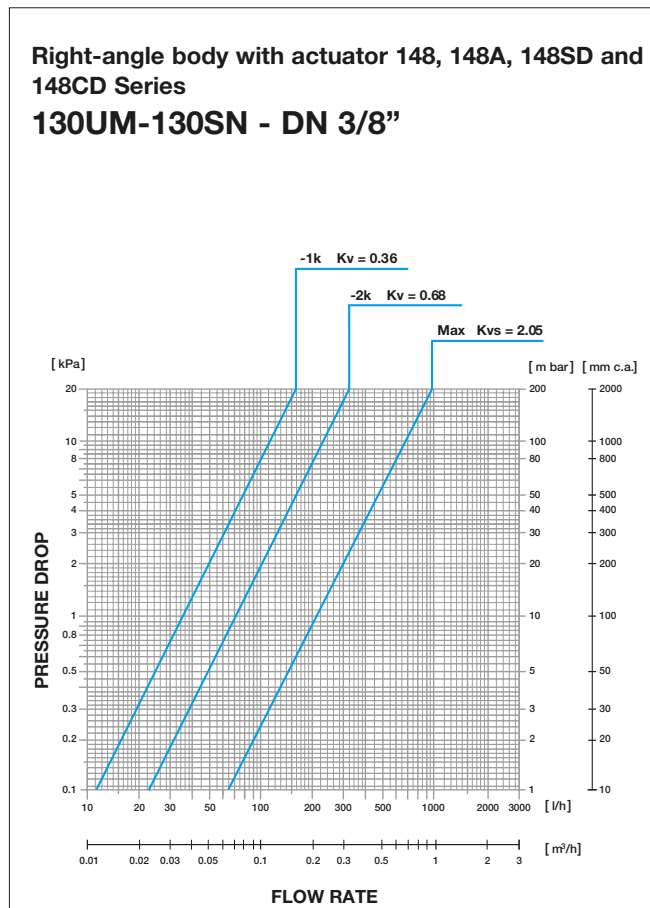

Right-angle body with actuator 148, 148A, 148SD and 148CD Series

130UM-130SN - DN 3/4"
Pre-setting OFF

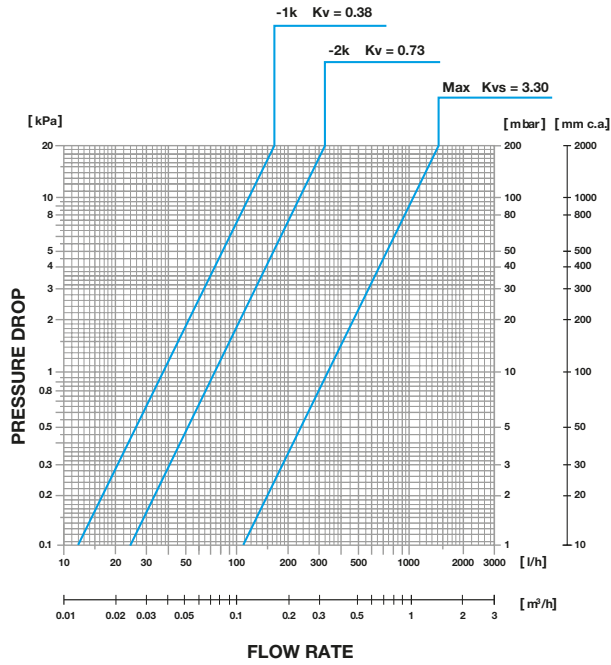

Straight body with actuator 148, 148A, 148SD and 148CD Series

131UM-131SN - DN 3/8"
Pre-setting OFF

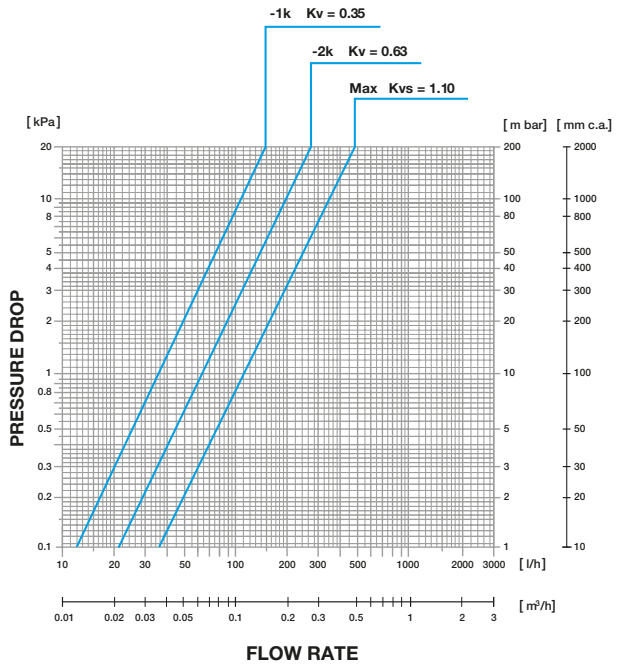

Straight body with actuator 148, 148A, 148SD and 148CD Series

131UM-131SN-1131UM - DN 1/2"
1131UM - DN 3/8"
Pre-setting OFF

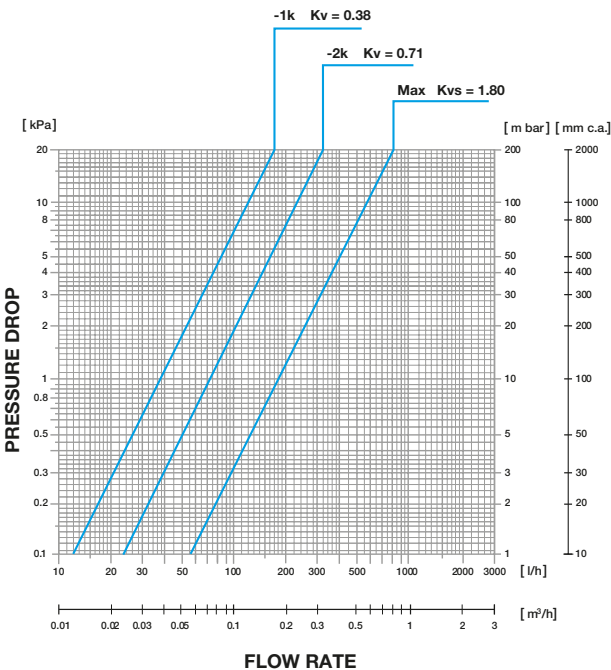

Straight body with actuator 148, 148A, 148SD and 148CD Series

131UM-131SN - DN 3/4"
Pre-setting OFF

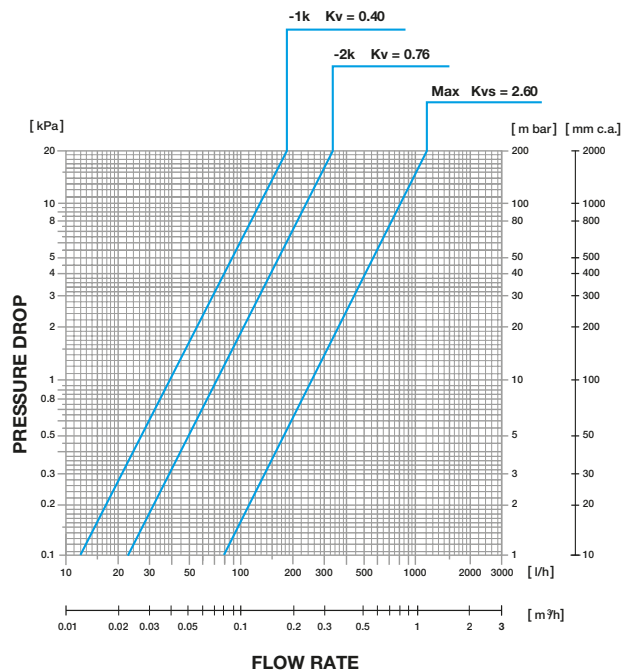

Right-angle body with pre-settings
130UM-130SN-1130UM-131UM-131SN
1131UM

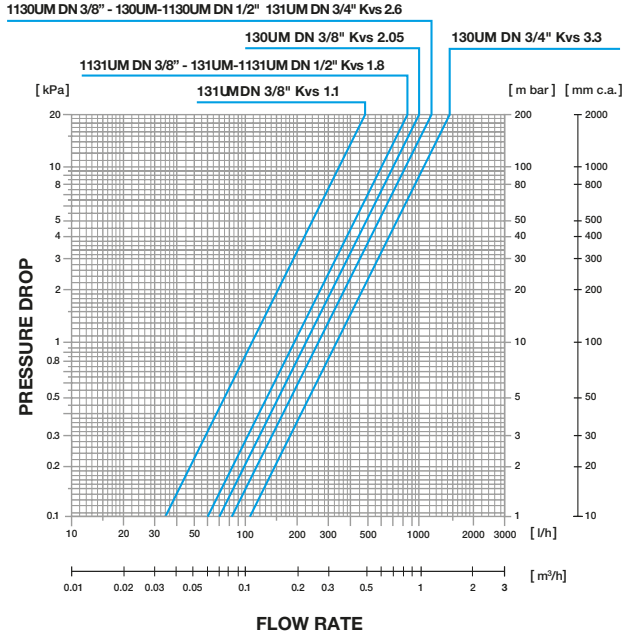

Right-angle body with pre-settings
130UM-130SN - DN 3/8"

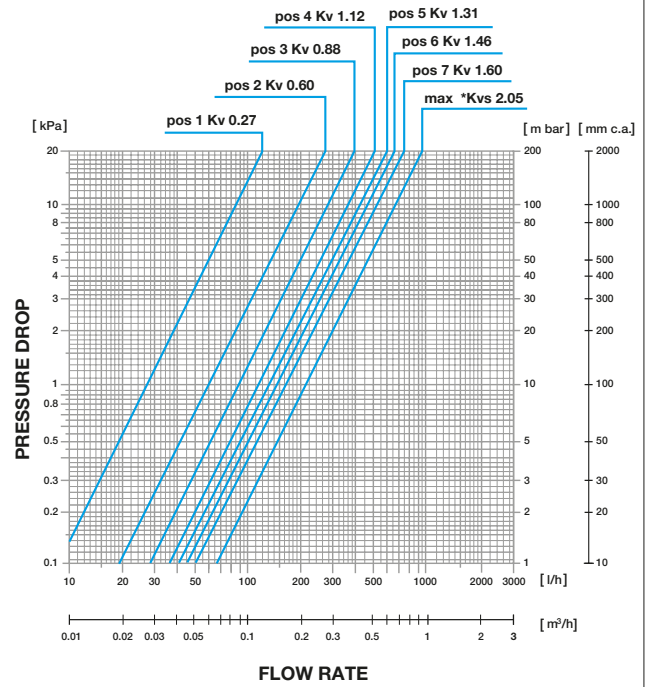

* Pre-setting excluded

Right-angle body with pre-settings
130UM-130SN-1130UM - DN 1/2"
1130UM - DN 3/8"

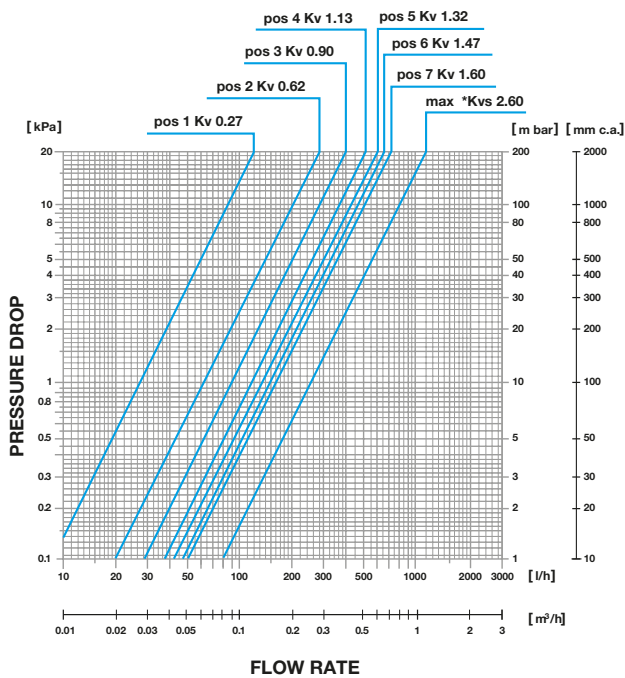

* Pre-setting excluded

Right-angle body with pre-settings
130UM-130SN - DN 3/4"

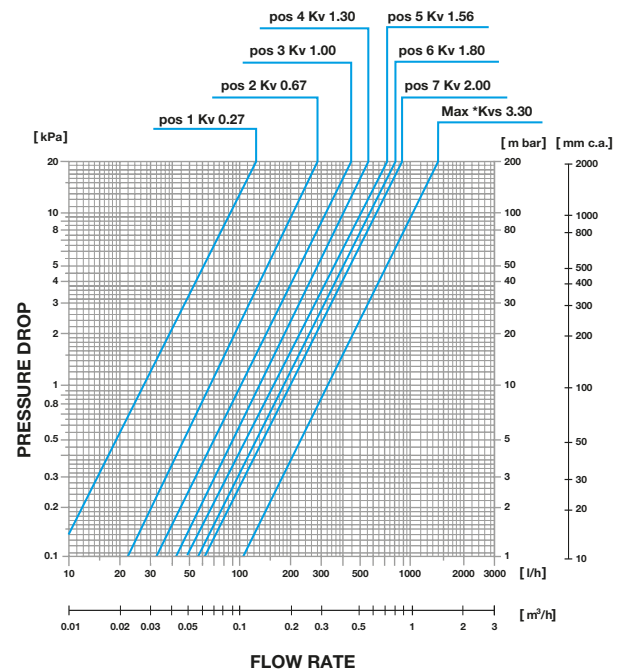

* Pre-setting excluded

**Straight body with pre-settings
131UM-131SN - DN 3/8"**

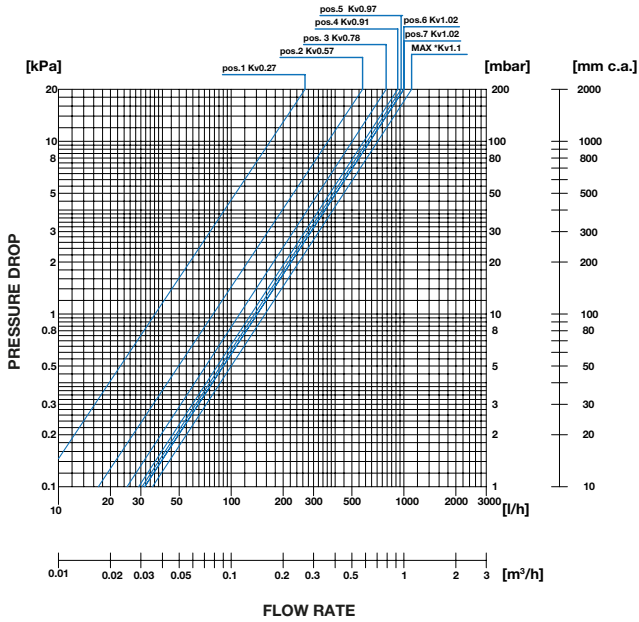

* Pre-setting excluded

**Straight body with pre-settings
131UM-131SN-1131UM - DN 1/2"
1131UM - DN 3/8"**

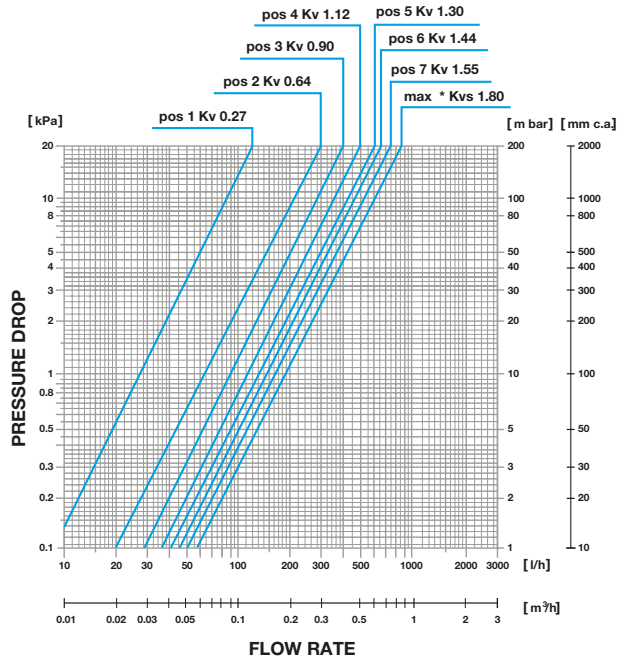

* Pre-setting excluded

**Straight body with pre-settings
131UM-131SN - DN 3/4"**

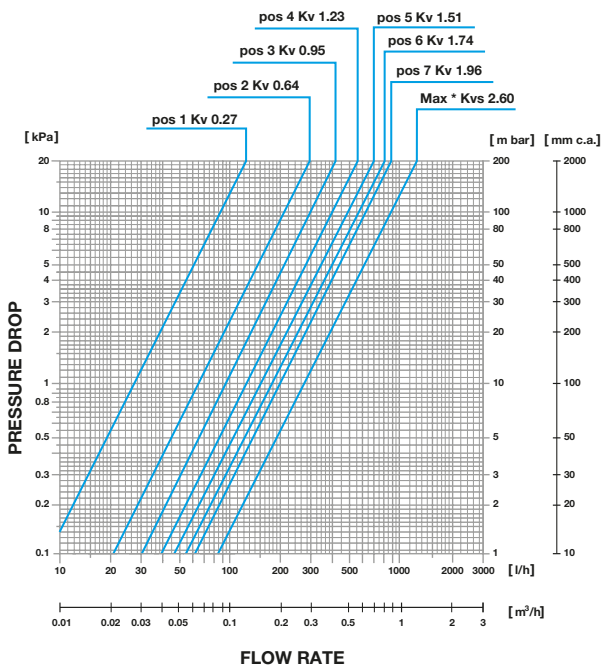

* Pre-setting excluded

Installation

Valve selection is based on the size of the connection to the radiator and the size of the connecting pipe. **130UM, 130SN, 1130UM, 131UM, 131SN and 1131UM Series** thermostat-adaptable valves can be installed on heat emitters supplied by iron, copper or plastic pipes, in conjunction with **195UM, 196UM, 1195UM and 1196UM Series** lockshields. Should it be necessary to apply a thermostat to the system, simply remove the protective cap of the valve and replace it with a thermostatic or electrothermal actuator by tightening the ring-nut. All this can be done without any plumbing work and with the system running.

Pre-setting

- 1) Remove the handwheel by turning it to the left (**Fig.1**)
- 2) Fully close the pre-setting ring-nut (**Fig.2**)
- 3) Open to the desired position by matching up the number with the reference notch (**Fig.3**)

The adjustment is valid only within the first lap.

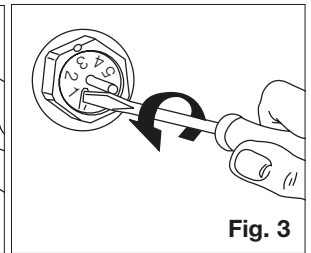
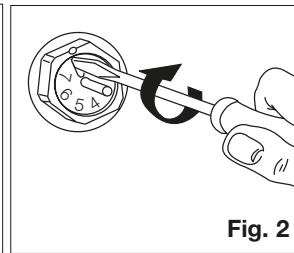
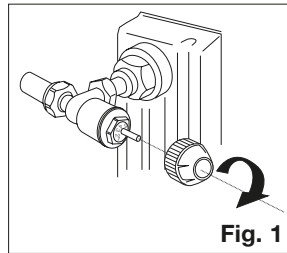

Kv values of the valve bodies only, in the various pre-setting positions							
Setting positions	130UM 3/8" 130SN 3/8"	130UM 1/2" 130SN 1/2" 1130UM 1/2" 1130UM 3/8"	130UM 3/4" 130SN 3/4"	131UM 3/8" 131SN 3/8"	131UM 1/2" 131SN 1/2" 1131UM 1/2" 1131UM 3/8"	131UM 3/4" 131SN 3/4"	Tol%
1	0.27	0.27	0.27	0.27	0.27	0.27	60
2	0.60	0.62	0.67	0.57	0.64	0.64	30
3	0.88	0.90	1.00	0.78	0.90	0.95	20
4	1.12	1.13	1.30	0.91	1.12	1.23	10
5	1.31	1.32	1.56	0.97	1.30	1.51	10
6	1.46	1.47	1.80	1.00	1.44	1.74	10
7	1.60	1.60	2.00	1.02	1.55	1.96	10
A*	2.05	2.60	3.30	1.10	1.80	2.60	10

*Pre-setting OFF

Overall dimensions (mm)

130UM

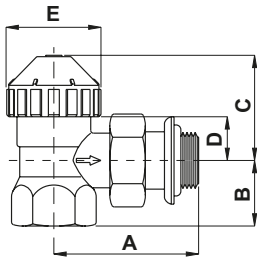

DN	A	B	C	D	E
3/8"	49	20	40	18	35
1/2"	53	23	40	18	35
3/4"	61	28	40	18	35

131UM

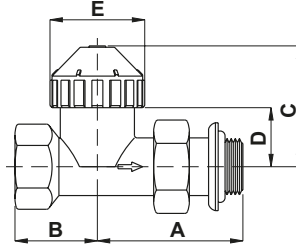

DN	A	B	C	D	E
3/8"	49	26	46.5	24.5	35
1/2"	53	29	46.5	24.5	35
3/4"	61	34	46.5	24.5	35

130SN

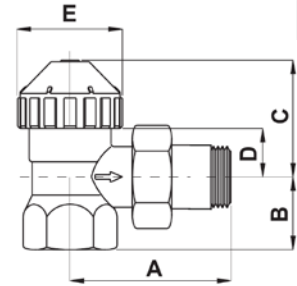

DN	A	B	C	D	E
3/8"	49	20	40	18	35
1/2"	51	23	40	18	35
3/4"	62	28	40	18	35

131SN

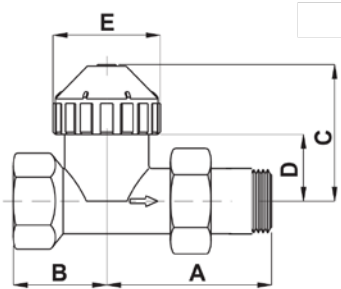

DN	A	B	C	D	E
3/8"	49	26	46,5	24,5	35
1/2"	51	29	46,5	24,5	35
3/4"	62	34	46,5	24,5	35

1130UM

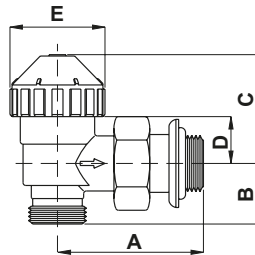

DN	A	B	C	D	E
3/8"	49	20,5	40	18	35
1/2"	53	20,5	40	18	35

1131UM

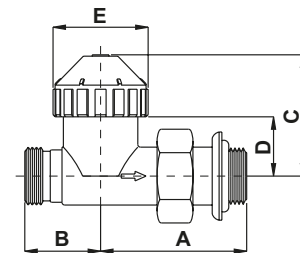

DN	A	B	C	D	E
3/8"	49	26	46,5	24,5	35
1/2"	53	26	46,5	24,5	35

Specification text

130UM/130SN Series

Right-angle nickel-plated brass thermostatic valve **130UM/130SN Series** WATTS brand with pre-setting. Disc stroke limiting device with nine reference positions. Disc assembly can be replaced without draining the system with key **225-RP130 Series** with EPDM seal. Replaceable spare part RI 130 stuffing box without draining the system. Easily removable polypropylene protective cap. Straight tailpiece with O-Ring and finishing washer. Maximum operating temperature: 110°C. Maximum admissible static pressure: 10 bar. Connection for iron pipe: 3/8"F-1/2"F-3/4"F. Kv: 2.05 (3/8"), 2.6 (1/2"), 3.3 (3/4"). Compatible with **148, 148A, 148SD and 148CD Series** thermostatic actuators with liquid-filled elements, and **22C, 22CX, 22CX5 and 26LC Series** electrothermal actuators. No special tools are required for assembly, which can be undertaken with the system running. UNI EN 215 certified, together with **148 and 148A Series** thermostatic actuators.

131UM/131SN Series

Straight nickel-plated brass thermostatic valve **131UM/131SN Series** WATTS brand with pre-setting. Disc stroke limiting device with nine reference positions. Disc assembly can be replaced without draining the system with key **225-RP130 Series** with EPDM seal. Replaceable spare part RI 130 stuffing box without draining the system. Easily removable polypropylene protective cap. Straight tailpiece with O-Ring and finishing washer. Maximum operating temperature: 110°C. Maximum admissible static pressure: 10 bar. Connection for iron pipe: 3/8"F-1/2"F-3/4"F. Compatible with **148, 148A, 148SD and 148CD Series** thermostatic actuators with liquid-filled elements, and **22C, 22CX, 22CX5 and 26LC Series** electrothermal actuators. No special tools are required for assembly, which can be undertaken with the system running. UNI EN 215 certified, together with **148 and 148A Series** thermostatic actuators.

1130UM Series

Right-angle nickel-plated brass thermostatic valve **1130UM Series** WATTS brand with pre-setting. Disc stroke limiting device with nine reference positions. Disc assembly can be replaced without draining the system with key **225-RP130 Series** with EPDM seal. Replaceable spare part RI 130 stuffing box without draining the system. Easily removable polypropylene protective cap. Straight tailpiece with O-Ring and finishing washer. Maximum operating temperature: 110°C. Maximum admissible static pressure 10 bar. Body connection: 3/8"M-1/2"M. Connection for copper or plastic/multi-layer pipe: 1/2"M. Kvs: 2.6. Compatible with **148, 148A, 148SD and 148CD Series** thermostatic actuators with liquid-filled elements, and **22C, 22CX, 22CX5 and 26LC Series** electrothermal actuators. No special tools are required for assembly, which can be undertaken with the system running.

1131UM Series

Straight nickel-plated brass thermostatic valve **1131UM Series** WATTS brand with pre-setting. Disc stroke limiting device with nine reference positions. Disc assembly can be replaced without draining the system with key **225-RP130 Series** with EPDM seal. Replaceable spare part RI 130 stuffing box without draining the system. Easily removable polypropylene protective cap. Straight tailpiece with O-Ring and finishing washer. Maximum operating temperature: 110°C. Maximum admissible static pressure: 10 bar. Body connection: 3/8"M-1/2"M. Connection for copper or plastic/multi-layer pipe: 1/2"M. Kvs at full opening: 1.8. Compatible with **148, 148A, 148SD and 148CD Series** thermostatic actuators with liquid-filled elements, and **22C, 22CX, 22CX5 and 26LC Series** electrothermal actuators. No special tools are required for assembly, which can be undertaken with the system running.



The descriptions and photographs contained in this product specification sheet are supplied by way of information only and are not binding.

Watts Industries reserves the right to carry out any technical and design improvements to its products without prior notice. Warranty: All sales and contracts for sale are expressly conditioned on the buyer's assent to Watts terms and conditions found on its website at www.wattswater.eu. Watts hereby objects to any term, different from or additional to Watts terms, contained in any buyer communication in any form, unless agreed to in a writing signed by an officer of Watts.



Watts Industries Italia S.r.l.

Via Brenno, 21 • 20853 Biassono (MB) • Italy
Tel. +39 039 4986.1 • Fax +39 039 4986.222
infowattsitalia@wattswater.com • www.watts.com