

Solar station

Instruction manual

EN

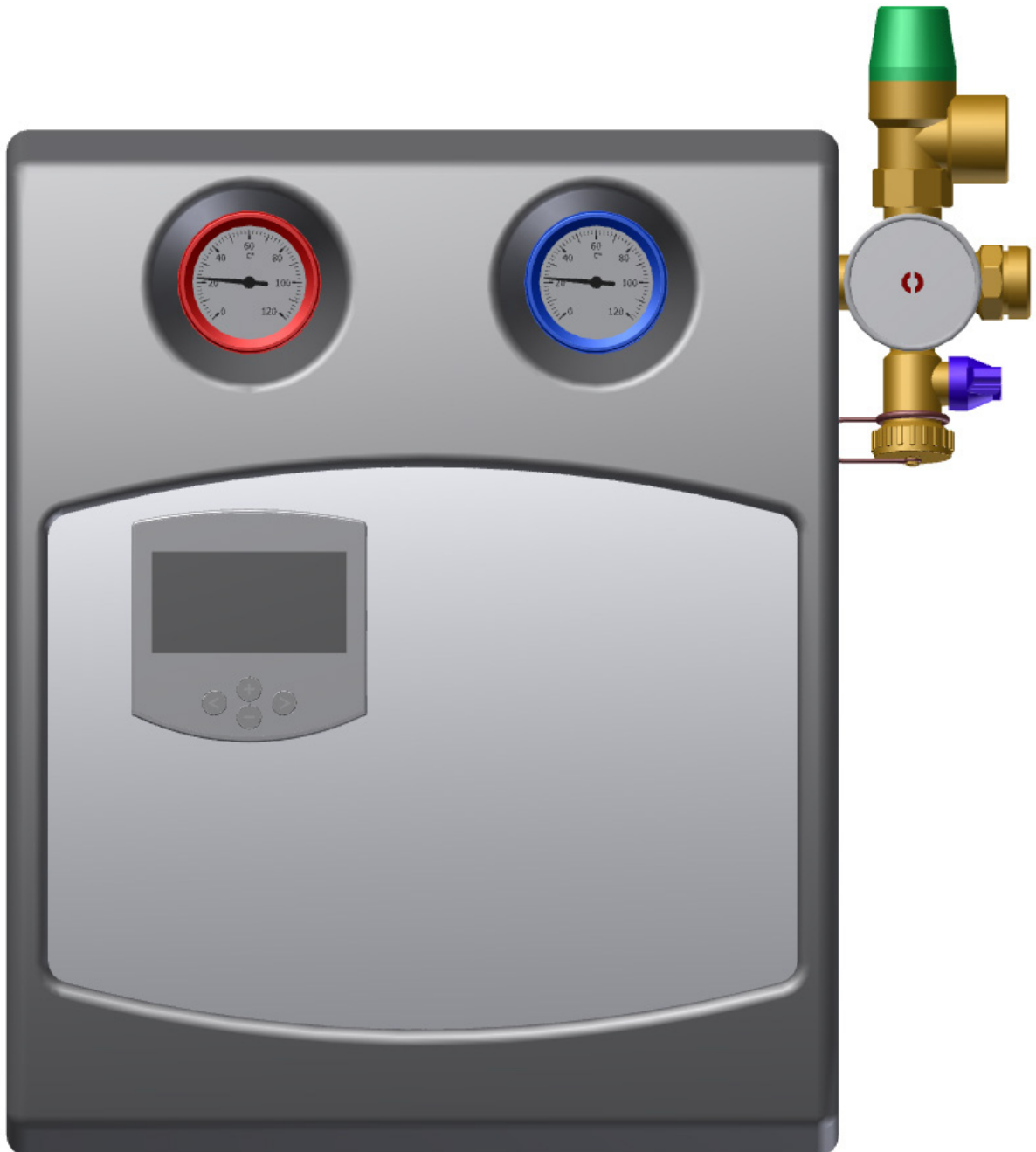

Solar station

Table of content

1	Key background information	3
1.1	Limitation of liability	3
1.2	Responsibilities of the operator	3
1.3	Documentation	3
	1.3.1 Contents and structure	3
	1.3.2 Labelling system used in the documentation	4
1.4	Target group	4
1.5	Replacing wear parts	4
2	Safety	5
2.1	Important safety notices	5
2.2	Instructions for correct use	5
	2.2.1 Area of use	5
	2.2.2 Environmental conditions relevant to safety	5
2.3	Observance of the operating instructions	6
2.4	Residual risks and safety measures	6
3	Component overview	7
4	Assembly and commissioning	9
4.1	Safety	9
4.2	Installation	10
4.3	Initial operation	12
5	Maintenance	15
5.1	Safety	15
5.2	Recommended maintenance intervals	15
5.3	Maintenance works	16
	5.3.1 Dismantle the circulation pump solar circuit	16
	5.3.2 Assemble the circulation pump solar circuit	17
	5.3.3 Adjust the flow rate	18
6	Technical data	19
7	Decommissioning, recommissioning	21
7.1	Decommissioning	21
7.2	Recommissioning	21
8	Dismantling	21
9	Disposal	21
9.1	Safety	21
9.2	Disposal	21

1 Key background information

1.1 Limitation of liability

The contents of these operating instructions have been created with due consideration of applicable legislation and standards.

The device has been developed in accordance with the technological state of the art¹.

The manufacturer accepts no liability for damage resulting from:

- ▶ Disregard for or non-compliance with the operating instructions
- ▶ Deliberate misuse
- ▶ Incorrect use
- ▶ The use of untrained professionals (for maintenance and repair work, etc.)
- ▶ Technical modifications to the device that have not been discussed with the manufacturer
- ▶ Use of spare parts that have not been approved by the manufacturer

1.2 Responsibilities of the operator

The safety, accident prevention and environmental protection regulations applicable to the area in which the device is used must be complied with.

The following is of particular relevance:

- ▶ The operator must ensure that these operating instructions are available for the entire life cycle of the solar station.
- ▶ The operator must ensure that the maintenance intervals described in these operating instructions are complied with.
- ▶ The operator must ensure that all safety devices are being checked for proper function and completeness.

NOTICE



When assembling and operating the solar station, be aware of country-specific standards and guidelines.

1.3 Documentation

1.3.1 Contents and structure

These operating instructions are an integral part of the device. They contain instructions and information regarding the safe use of the device and must be made available to all users for the device's entire life cycle.





These operating instructions are intended for use by trained professionals.

¹ Technical modifications reserved!

Solar station

1.3.2 Labelling system used in the documentation

The following types of alert are used:

Alert type	Representation	Meaning
Acute danger of death	 DANGER	Dangerous situation that will inevitably cause death or severe injury if it is not avoided
Risk of death and severe injury	 WARNING	Dangerous situation that may cause severe injury or death if it is not avoided
Risk of mild to moderate injury	 CAUTION	Hazardous situation which might entail minor or major injuries if not prevented.
Information, tips to make operation easier	 NOTICE	Indicates information that does not relate to personal hazards, e.g. warnings regarding material damage

-  Indicates a general safety notice
- Indicates an instruction
- ⇒ Indicates the consequences of an action

1.4 Target group

These operating instructions are intended for use by trained professionals.

The operator of this device must ensure that suitable and safe conditions are in place as described in these operating instructions.

Professional – Trained expert who understands the risks of the solar station and who is familiar with the technology used in the device. Professionals are trained and capable of assembling, maintaining and repairing the device.

1.5 Replacing wear parts

Be aware that the solar station contains parts which, depending on how frequently and how much they are used, will be subject to technology-related wear and tear, even if they are cared for and maintained properly. Mechanical parts and components that come into contact with hot water and steam are particularly affected by this, such as hoses, gaskets, valves, etc.

Wear-related defects of course do not represent faulty workmanship and are therefore not covered by the warranty or guarantee; regardless of this, faults and malfunctions must always only be rectified by trained professionals. For more information, contact your dealer.

2 Safety

2.1 Important safety notices

- ⚠ *Read these operating instructions carefully before use.*
- ⚠ *Only connect the solar station to a power supply that complies with the mains voltage specifications stated on the solar station's rating plate.*
- ⚠ *Before carrying out any maintenance, cleaning or repair work, the power supply to the solar station must be disconnected.*
- ⚠ *Maintenance, cleaning and repair work must only be carried out by trained professionals.*
- ⚠ *In the event of damage to the solar station or if its function is impaired, the solar station must not be used. Contact your dealer immediately.*
- ⚠ *Note the maintenance instructions and intervals.*
- ⚠ *Protect the solar station from the influences of weather.*
- ⚠ *Never use the solar station outdoors.*
- ⚠ *For your own safety and to ensure the long service life of the solar station, you should only use original spare parts.*
- ⚠ *The device must only be used in accordance with the instructions for correct use.*

2.2 Instructions for correct use

2.2.1 Area of use

The solar station has been built in accordance with the technological state of the art and in compliance with safety technology regulations. No liability will be accepted for any damaged cause by inappropriate use, misuse, incorrect connections or incorrect maintenance / repair by untrained personnel. Such cases will also invalidate all warranty clauses.

The solar station is used to transport heat transfer medium in solar thermal systems.
The solar station is fully pre-assembled and designed for installation on a wall.

The solar station is not intended to be used by persons (including children) with limited physical, sensory or mental capacities or a lack of knowledge and experience.

2.2.2 Environmental conditions relevant to safety

- The solar station must not be assembled or operated outdoors.
- The components are not UV resistant.
- The installation location for the solar station must be selected so that maintenance and repair work can be carried out when required.

Solar station

2.3 Observance of the operating instructions

NOTICE	
	<p>Read these operating instructions carefully before use.</p> <p>To ensure the device is operated safely, the instructions in this operating manual as well as regional regulations (e.g. health and safety regulations) that must be made available to the operator of the device must be complied with.</p>

2.4 Residual risks and safety measures

DANGER	
	<p>Electrical energy!</p> <p>Risk of death from electric shock.</p> <ul style="list-style-type: none">➤ Do not touch live cables or components with wet hands.➤ Be aware of health and safety regulations when handling electric current.

WARNING	
	<p>Hot water!</p> <p>Risk of severe scalding.</p> <ul style="list-style-type: none">➤ Fit suitable scald protection (such as a safety fitting or thermostatic mixer tap) at each draw-off point.➤ Further instructions regarding scald protection can be found in DIN 1988 Sheet 2, Point 4.2.

WARNING	
	<p>Hot water/heat transfer medium!</p> <p>Risk of severe scalding.</p> <ul style="list-style-type: none">➤ When draining the solar station, do not touch the hot water.➤ Allow the solar station to cool down before carrying out any maintenance, cleaning or repair work.

CAUTION	
	<p>Working on the device by inadequately trained personnel!</p> <p>Risk of injury and material damage.</p> <ul style="list-style-type: none">➤ Maintenance, cleaning and repair work must only be carried out by trained professionals.

3 Component overview

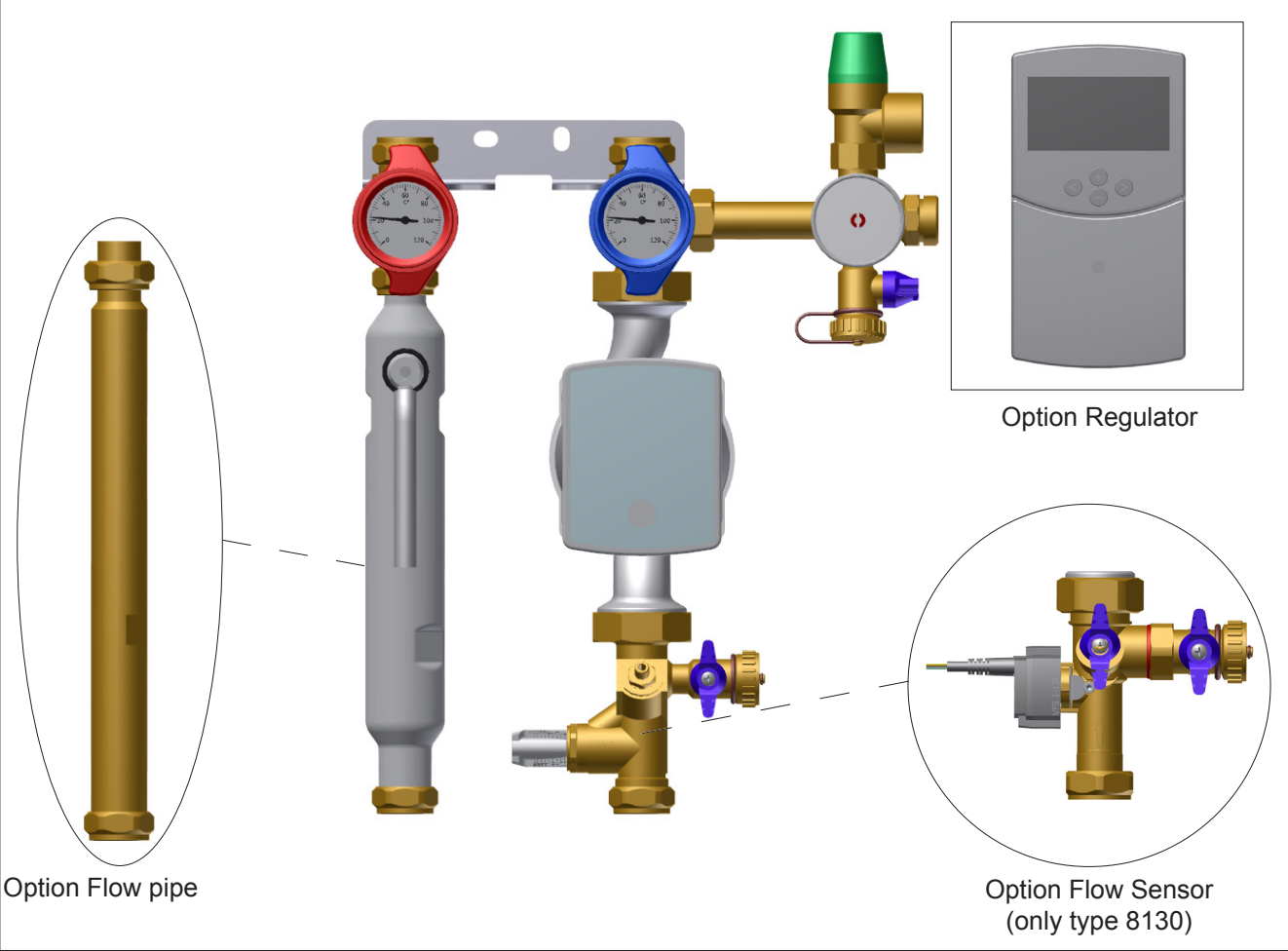

Fig. 1: Type overview 8130/8180

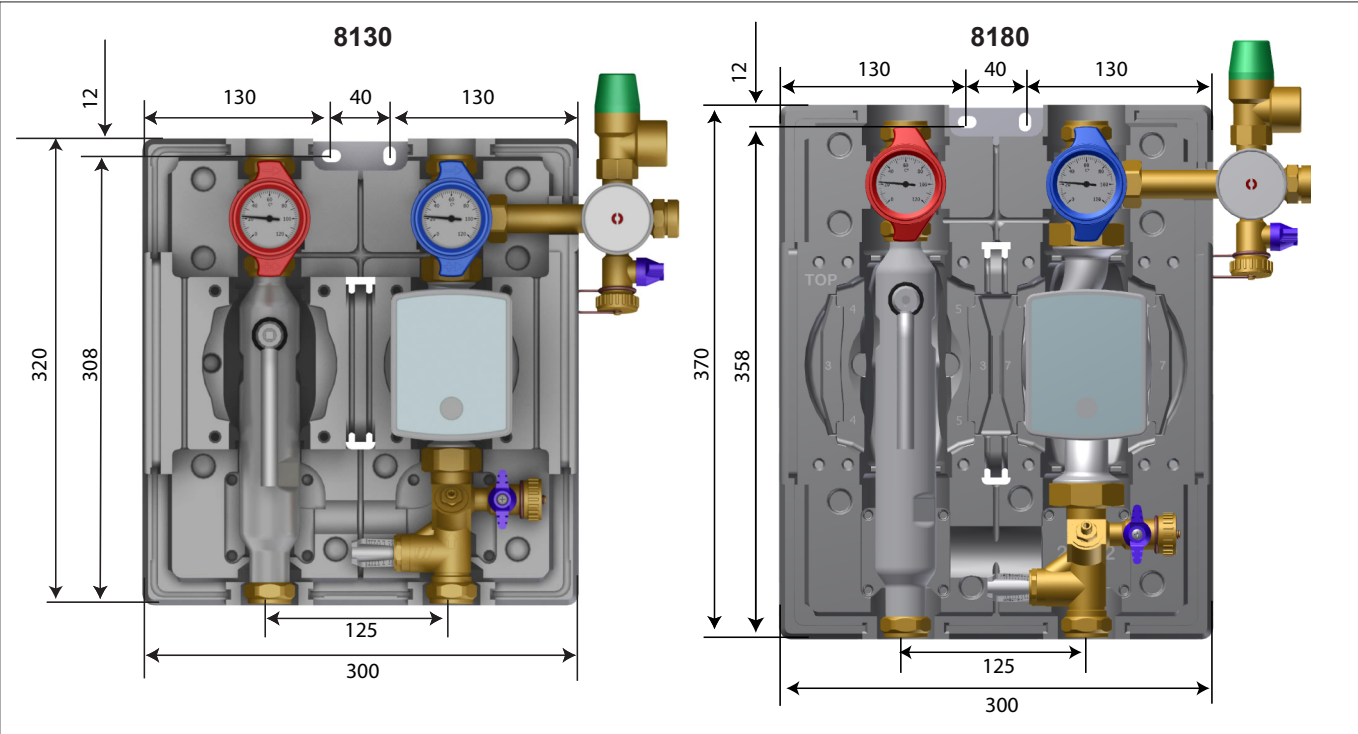

Fig. 2: Dimensions [mm]

Solar station

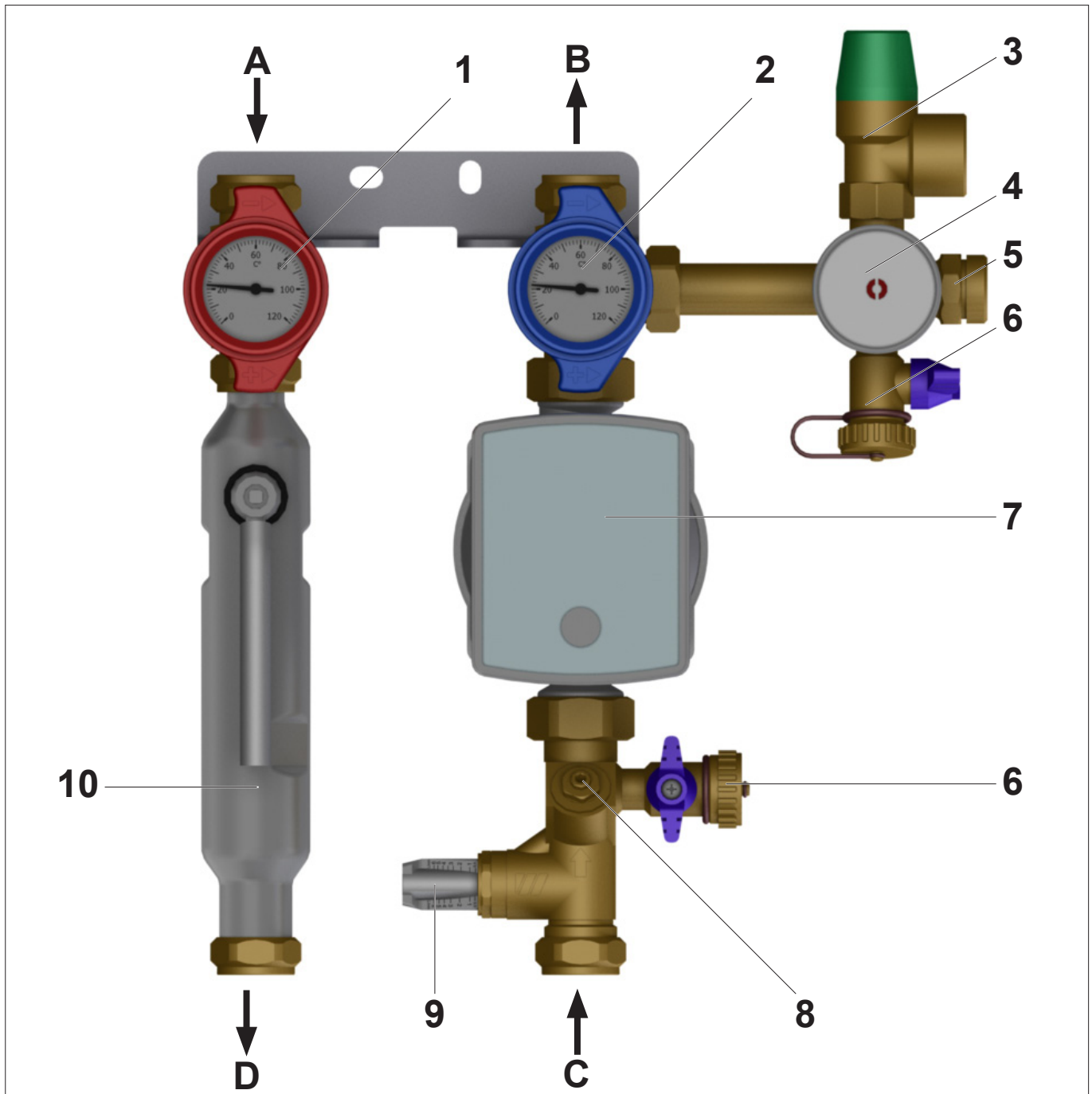







Fig. 3: Component overview (represented in type 8130 with venting pipe and WattFlow)

- | | | | |
|---|---|----|---|
| 1 | Ball valve with thermometer (supply line) | 6 | Rinsing and filling device with drain tap |
| 2 | Ball valve with thermometer (return line) | 7 | Circulation pump (solar circuit) |
| 3 | Solar safety valve | 8 | WattFlow: Regulating and gate valve |
| 4 | Gauge | 9 | WattFlow: Flow indicator |
| 5 | Connection for expansion container | 10 | Venting pipe (with venting valve) |
-
- | | | | |
|---|------------------|---|-------------|
| A | Collector supply | C | Supply line |
| B | Collector return | D | Return line |

4 Assembly and commissioning

4.1 Safety

HAZARD	
	<p>Electrical Energy!</p> <p>Mortal danger through electrical shock.</p> <ul style="list-style-type: none"> ➤ Do not touch the live cables or components with moist hands. ➤ Follow the accident prevention regulations when dealing with electrical current.
CAUTION	
	<p>Hazard through material damages!</p> <p>The pump assembly is not protected against spraying and dripping water.</p> <ul style="list-style-type: none"> ➤ Install the solar station only in a dry location.
CAUTION	
	<p>Material damages through pressure shocks!</p> <p>Occurrence of pressure shocks caused by rapid opening of the gate valves.</p> <ul style="list-style-type: none"> ➤ Open the gate valves always slowly and in a controlled manner.
CAUTION	
	<p>Bad water quality/heat transfer medium!</p> <p>Freezing hazard.</p> <ul style="list-style-type: none"> ➤ In the solar equipments only use heat transfer medium with suitable freeze protection (e.g. water glycol mix with max. 50% of glycol).
NOTE	
	<p>The assembly and commissioning of the solar station may be performed only by qualified professional technicians.</p> <p>Please follow the country-specific standards and directives when assembling and commissioning the solar station!</p> <p>Do not make any changes to the components (e.g. pumps, valves etc.), supply and discharge lines, and/or safety equipments which may impair the operational safety of the solar station.</p> <p>Please ensure that the power supply to the solar station is always freely accessible.</p>
NOTE	
	<p>Wear personal safety equipment during maintenance, cleaning and repair work.</p>

Solar station

4.2 Assembly

NOTE



Install the solar station in such a way that it is placed at eye level.

The solar station can also be installed to a pipe (e.g. at the storage) as an option.

- Dismantle the front encasing of the solar station.

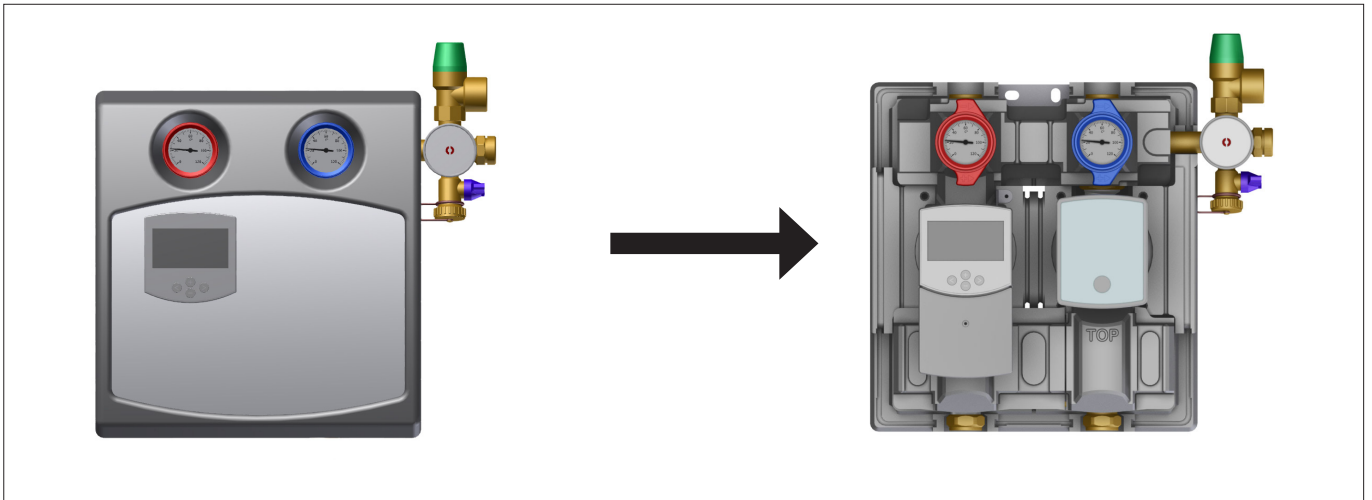

Fig. 4: Dismantle encasing (represented in type 8130 + controller)

- Mark the drilling points for installing the solar station.

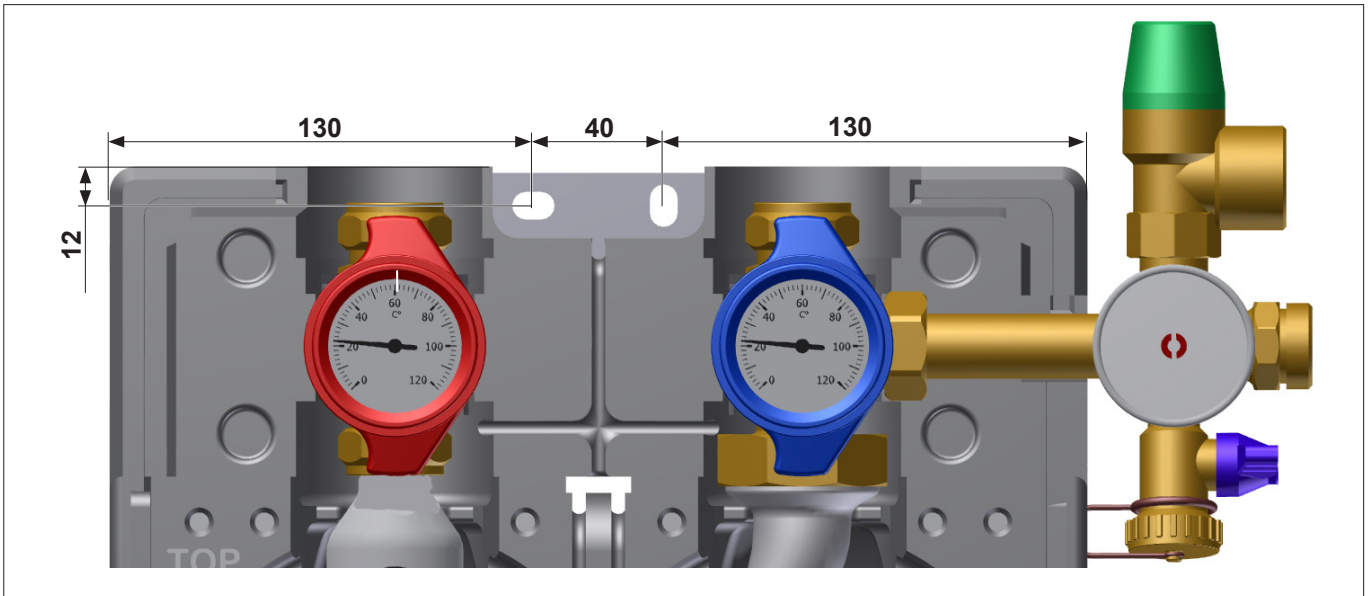

Fig. 5: Drilling dimensions [mm]

- Drill the holes corresponding to the screw and anchor size.
- Place the anchor.
- Insert the pump assembly.
- Screw the screws into the anchor.
- Install the safety valve at the outlet of the return line (Pos. A) of the solar station.

WARNING



Scalding hazard caused by escaping heat transfer medium at the safety valve!

Severe scalding possible.

- Install a temperature-resistant outlet pipe.
- Install a collection container.

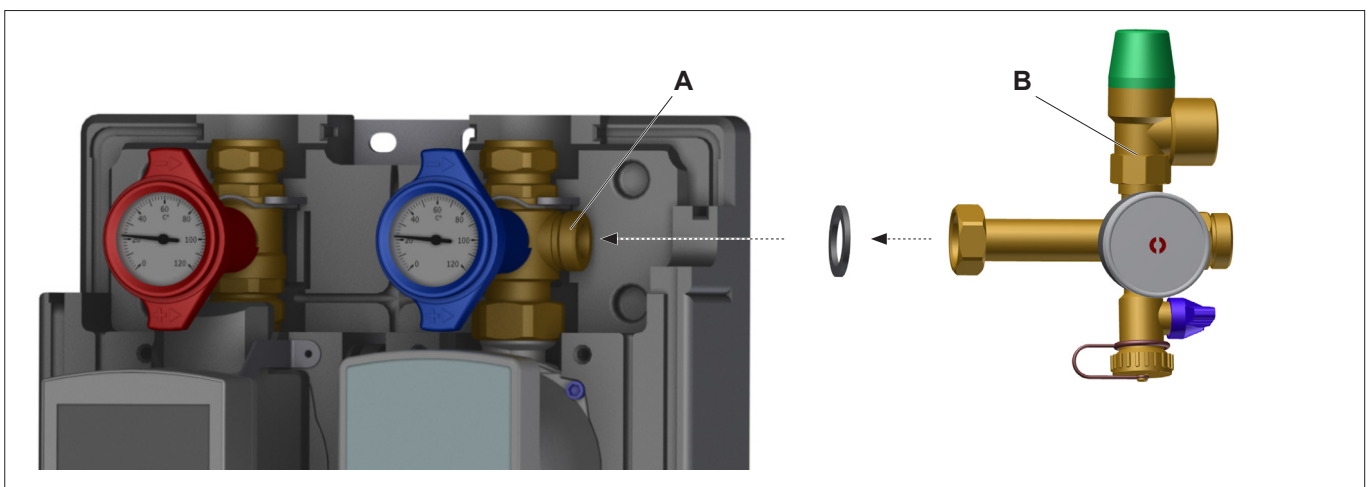

Fig. 6: Install safety valve

- Connect the supply and return line of the solar circuit (Pos. A+B, see Fig. 3 on page 8) and of the storage circuit (Pos. C+D, see Fig. 3 on page 8).
- Check all the screw connections for firm seating.

Solar station

4.3 Initial operation

Fill and rinse the solar station

CAUTION



Material damages through frost or steam formation!

Formation of frozen water or steam, if the solar station is rinsed and filled in direct sunlight or freezing temperatures.

- Rinse and fill the solar station only if no direct sunlight or frost is expected.

NOTE



Use suitable filling and rinsing pumps for rinsing and filling the solar station. Ensure that there is sufficient heat transfer medium in the filling and rinsing pump for filling and rinsing. Follow the instructions for filling the solar station.

- Stop the power supply of the solar station and secure it against being switched on again.

HAZARD



Electrical Energy!

Mortal danger through electrical shock.

- Do not touch the live cables or components with moist hands.
- Follow the accident prevention regulations when dealing with electrical current.
- Stop the power supply of the solar station before undertaking any maintenance, cleaning and repair works and secure it against being switched on again.

- Dismantle the front encasing of the pump assembly (see Fig. 4 on page 10).
- Connect the filling hose (pressure hose) of the external rinsing and filling pump to the intake (Pos. D) of the safety valve and the rinsing hose to the return pipe (Pos. F).

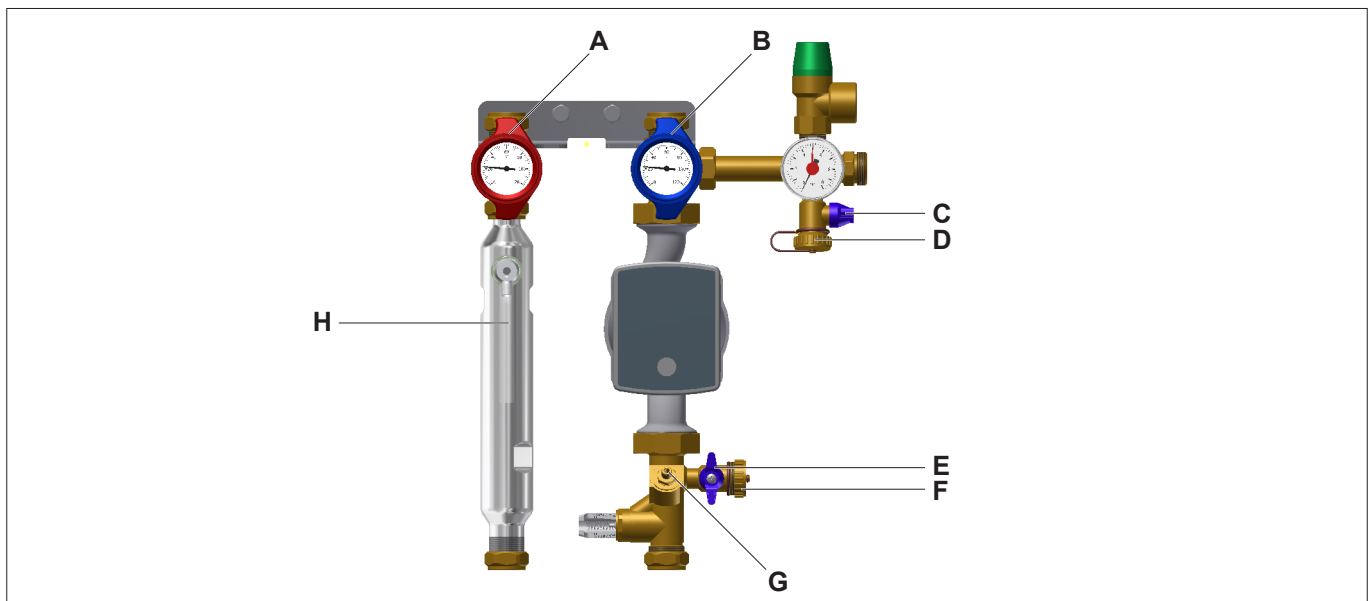

Fig. 7: Filling and rinsing connection

- Open the ball valve (Pos. C, see Fig. 7 on page 12) at the supply line.

- Open the supply line ball valve (multifunction armature, Pos. A, see Fig. 7 on page 12) by rotating the thermometer handle (see “ thermometer handle settings” on page 6).
- Close the return line ball valve (multifunction armature, Pos. B, see Fig. 7 on page 12) by rotating the thermometer handle (see “ thermometer handle settings” on page 14).

NOTE



The multifunction armature of the supply and return line (multifunction armature, Pos. B, see Fig. 7 on page 12) can be opened at 45° (emptying position, see Fig. 7 on page 12) if required.

- Open the regulating and gate valve (Pos. G, see Fig. 7 on page 12).
 - Fill the solar station with the help of rinsing and filling pump and then rinse the solar circuit sufficiently to flush the air out of the solar circuit.
 - Open the return line ball valve (multifunction armature, Pos. B, see Fig. 7 on page 12) during the rinsing and filling process 2-3 times to vent the circulation pump.
- ⚠ *If the rinsing and filling pump is suitable for pressurisation, the corresponding system pressure can be created.*
- Close the filling and emptying valve (Pos. E, see Fig. 7 on page 12).
 - Close the filling and emptying valve (Pos. C, see Fig. 7 on page 12)
 - Switch off the rinsing and filling pump.
 - Open the return line ball valve (multifunction armature, Pos. B, see Fig. 7 on page 12) by rotating the thermometer handle (see „thermometer handle settings” on page 14).

WARNING



High temperatures!

High temperature may arise in the collectors even if there is little sunlight.

- Vent the solar station only with covered collectors.
- Follow the instructions of the collector manufacturer.

- Remove the filling hose (pressure hose) of the external rinsing and filling pump from the supply line (Pos. C, see Fig. 7 on page 4) and the rinsing hose from the return line (Pos. F, see Fig. 7 on page 4) of the safety valve and screw the caps to the connections.
- Check the Fig. 7 on page 12 for tightness.
- Open the supply and return line ball valves (multifunction armatures, Pos. A+B, see Fig. 7 on page 12) completely.

Solar station



Fig. 8: Thermometer handle settings

- A Operational setting: check valve operational; ball valve open
- B Empty: check valve open; ball valve ½ open (only in the supply run)
- C Service setting: ball valve closed

Connect the power supply

- Close the power supply of the solar station.

NOTE



The electrical installation of the solar station may be done only by trained technicians.
The connection diagram is included in the controller documentation.

⇒ The solar station switches on automatically after connecting the power supply.

- Program the controller if required according to the respective controller manual.

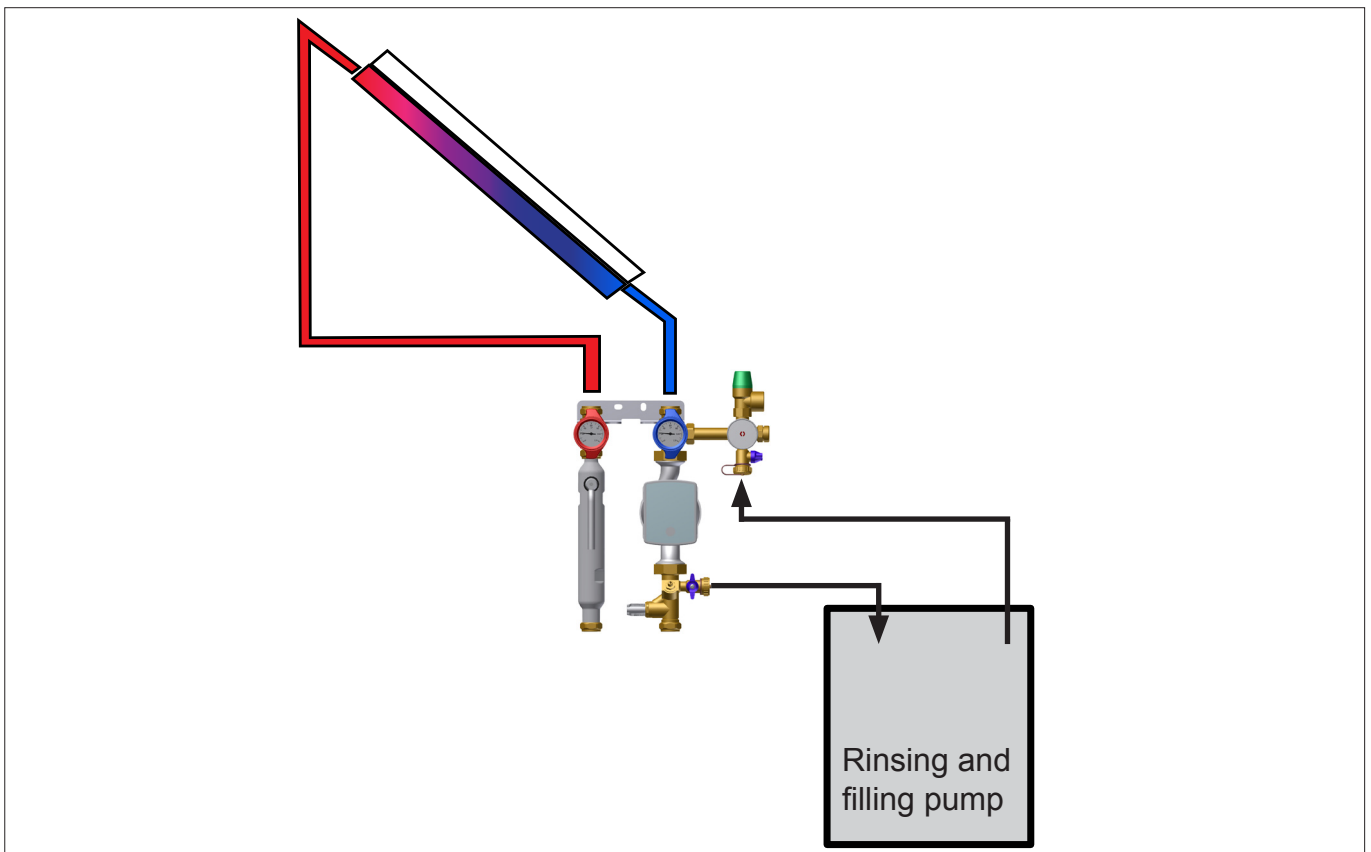

Fig. 9: Rinsing and filling diagram

5 Maintenance

5.1 Safety

HAZARD



Electric Energy!

Mortal danger through electric shock.

- Do not touch the live cables or components with moist hands.
- Follow the accident prevention regulations when dealing with electric current.
- Stop the power supply of the solar station before undertaking any maintenance, cleaning and repair works and secure it against being switched on again.

WARNING



Hot water/heat transfer medium!

Severe burns possible.

- Let the solar station cool down before undertaking any maintenance, cleaning and repair works.
- Do not touch the hot water when emptying the solar station.

WARNING



Hot surfaces!

Severe burns possible.

- Let the solar station cool down before undertaking any maintenance, cleaning and repair works.
- Do not touch the pipes and components when doing maintenance, cleaning and repairs works.
- Wear heat-resistant safety gloves when you need to work with hot components.

5.2 Recommended maintenance intervals

Job	Interval
Check gate and ball valves for smooth movement	Annual
Watch out for any noise development in the pump	Annual
Check the solar station for leakages (visual inspection)	Annual
Check the solar safety valve	Annual
Check the WattFlow for proper operation	Annual

Solar station

5.3 Maintenance works

5.3.1 Dismantle the circulation pump solar circuit

- Stop the power supply of the solar station and secure it against being switched on again.

HAZARD



Electric Energy!

Mortal danger through electric shock.

- Do not touch the live cables or components with moist hands.
- Follow the accident prevention regulations when dealing with electric current.
- Stop the power supply of the solar station before undertaking any maintenance, cleaning and repair works and secure it against being switched on again.

- Dismantle the front encasing of the solar station (see Fig. 4 on page 10).
- Close the ball valves (multifunction armature, Pos. A) by rotating the thermometer handle (see “thermometer handle setting” on page 14).
- One after another dismantle the lower insulation (Pos. B), the thermometer handles supply and return line (Pos. A) as well as the upper insulation (Pos. C).

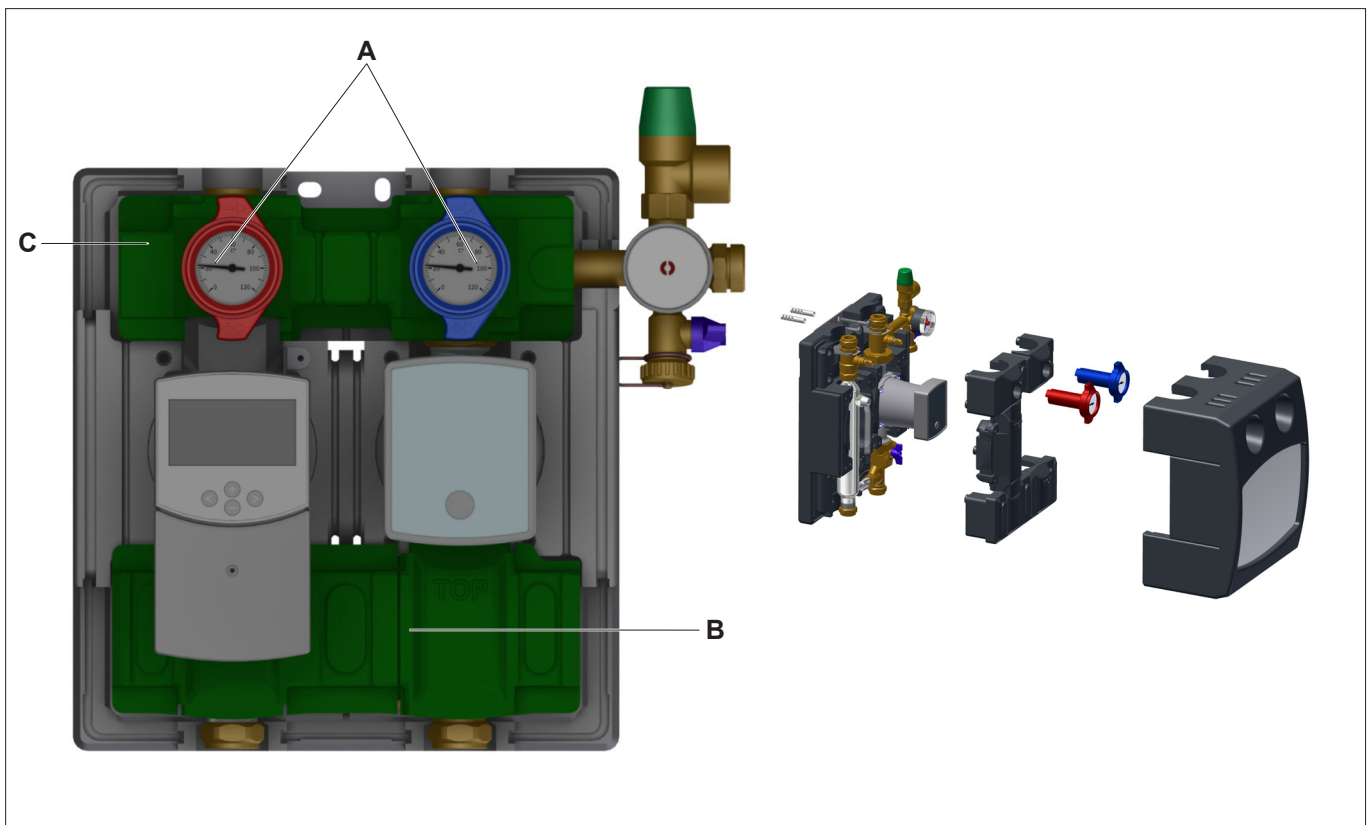

Fig. 10: Dismantle insulations (represented in type 8130 with venting pipe and regulator)

- Close the regulator/gate valve (Pos. C, see Fig. 11 on page 17).
- Loosen the wiring of the solar pump (Pos. D, see Fig. 11 on page 17).

- Loosen the nuts (Pos. B) and dismantle the circulation pump (Pos. D).

WARNING



Hot water/heat transfer medium!

Severe burns possible through fluids escaping under pressure.

- Let the solar station cool down before undertaking any maintenance, cleaning and repair works.
- Open the nuts (Pos. B) of the circulation pump (Pos. D) slowly and in a controlled manner.

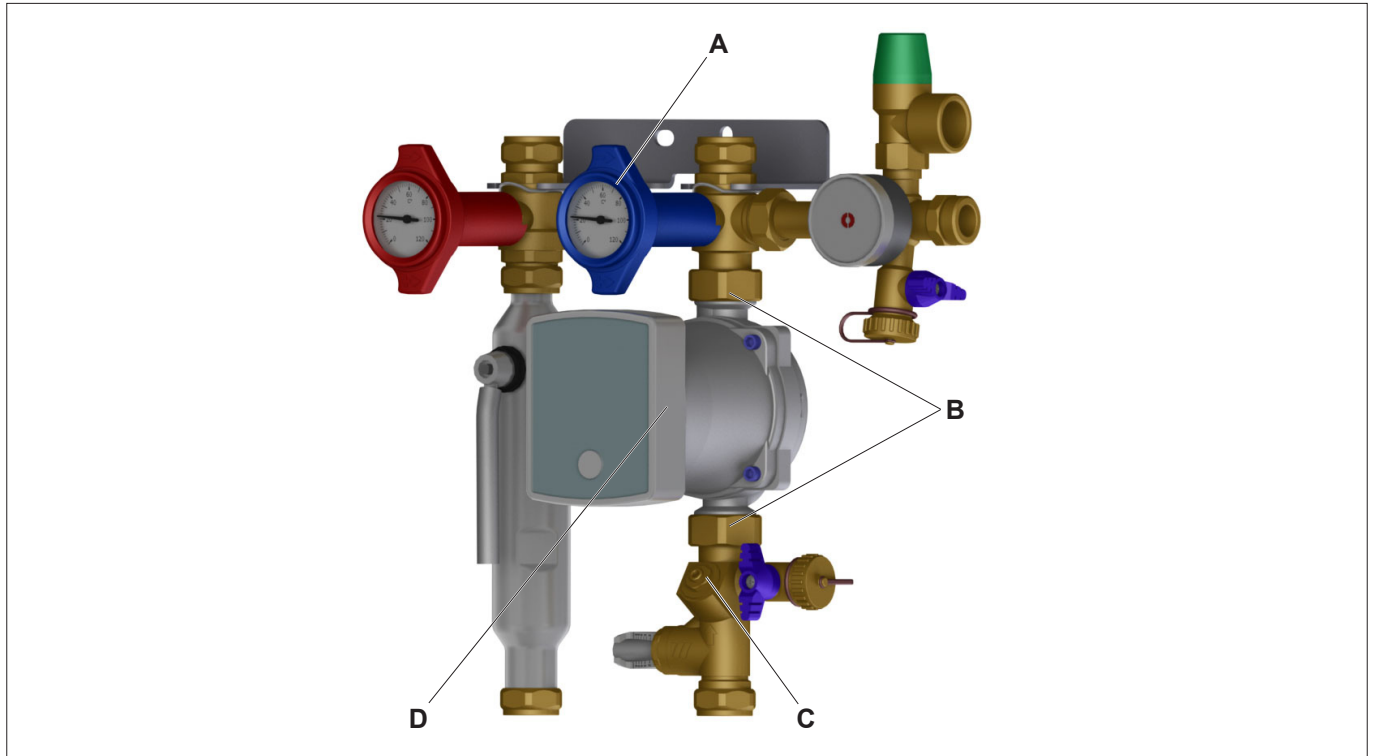

Fig. 11: Dismantle circulation pump solar circuit (represented type 8130 with venting pipe and regulator)

5.3.2 Assemble the circulation pump solar circuit

- Replace the damaged or defective sealings.
- Insert the circulation pump and tighten the nuts (tightening torques see „6 Technical data“ on page 19).
- Connect the wiring of the circulation pump.
- Slowly** open the return ball valve (multifunction armature, Pos. A, see Fig. 11 on page 17) by rotating the thermometer handle 90 degree in the clockwise direction till the stop (see „Thermometer handle settings“ on page 14).
- Slowly** open the regulator/gate valve (Pos. C, see Fig. 11 on page 17).
- Gently** pressurise the solar station and vent it if required.
- Reconnect the power supply of the solar station.

Solar station

5.3.3 Adjust the flow rate

NOTE



For adjusting the flow rate the solar station must be completely cooled off (temperature range 30-40°C).

In case of variants with Flow Sensor the flow rate is automatically controlled. An adjustment is not required.

- Set the ball valves (Pos. A; see Fig. 10 on page 16) to position B.



Fig. 12: Thermometer settings

- A Operational setting: check valve operational; ball valve open
- B Empty: check valve open; ball valve ½ open
- C service setting: ball valve closed

- Adjust the flow rate with Allen wrench SW 4 (Pos. C, see Fig. 11 on page 17).
- Select operating mode “manual mode” at the controller.
- Check the adjusted flow rate in the inspection window of the WattFlow (Pos. A).

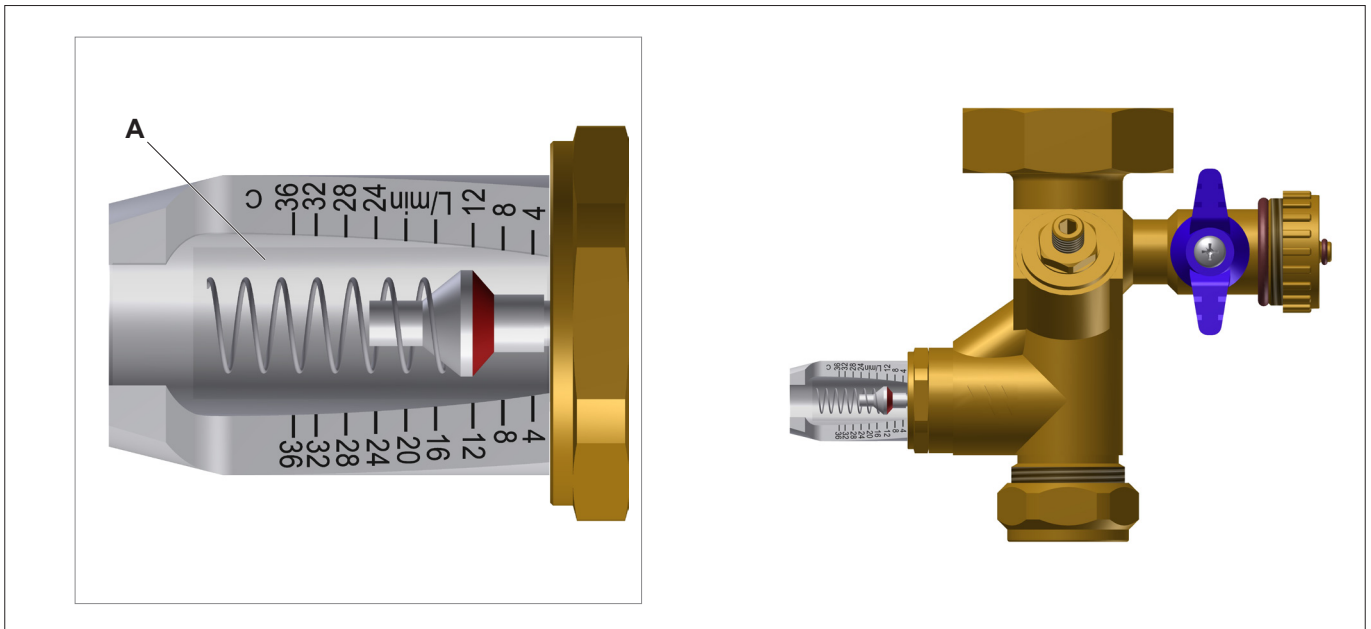

Fig. 13: Regulator valve WattFlow (Example: flow rate 12L/min)

- Vent the solar station if required.

6 Technical data

General	
Dimensions (W x H x D)	
Type 8130	300 x 320 x 235 mm
Type 8180	300 x 370 x 240 mm
Weight	
Type 8130	6.5 - 8.5 kg (type dependent)
Type 8180	7.5 - 10 kg (type dependent)
Power supply	See pump/regulator manual
Maximum operating pressure	10 bar
Maximum permissible operating temperature	120 °C (check pump specification)

Circulation pumps
Technical data of the circulation pumps should be taken from the respective pump documentation.

Materials	
Armatures	Pressed brass Ms58 (CW614N)
Tube	Precision steel pipe with surface treatment
Springs	Stainless steel
O-Ring	EPDM-Elastomere (Solar-suitable)
Flat gaskets	AFM34
Ball seatings	PTFE (Solar-suitable)
Check valves VL + RL	Metal

Tightening torques for screws with Reinz AFM 34 + Klingerit gaskets	
$\frac{3}{4}$ "	35 Nm
1"	55 Nm
$1\frac{1}{4}$ "	90 Nm
$1\frac{1}{2}$ "	130 Nm
2"	190 Nm

Solar station

Characteristic curves

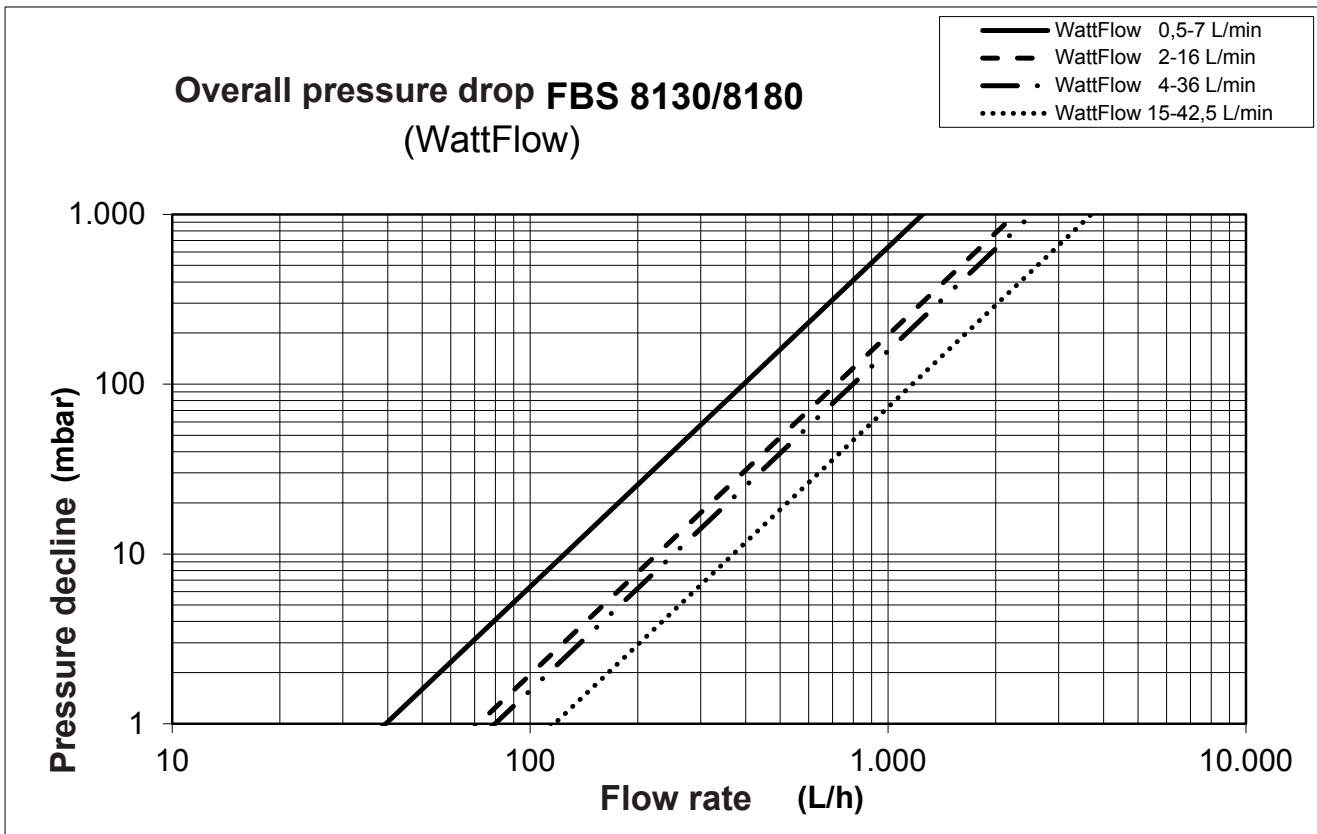
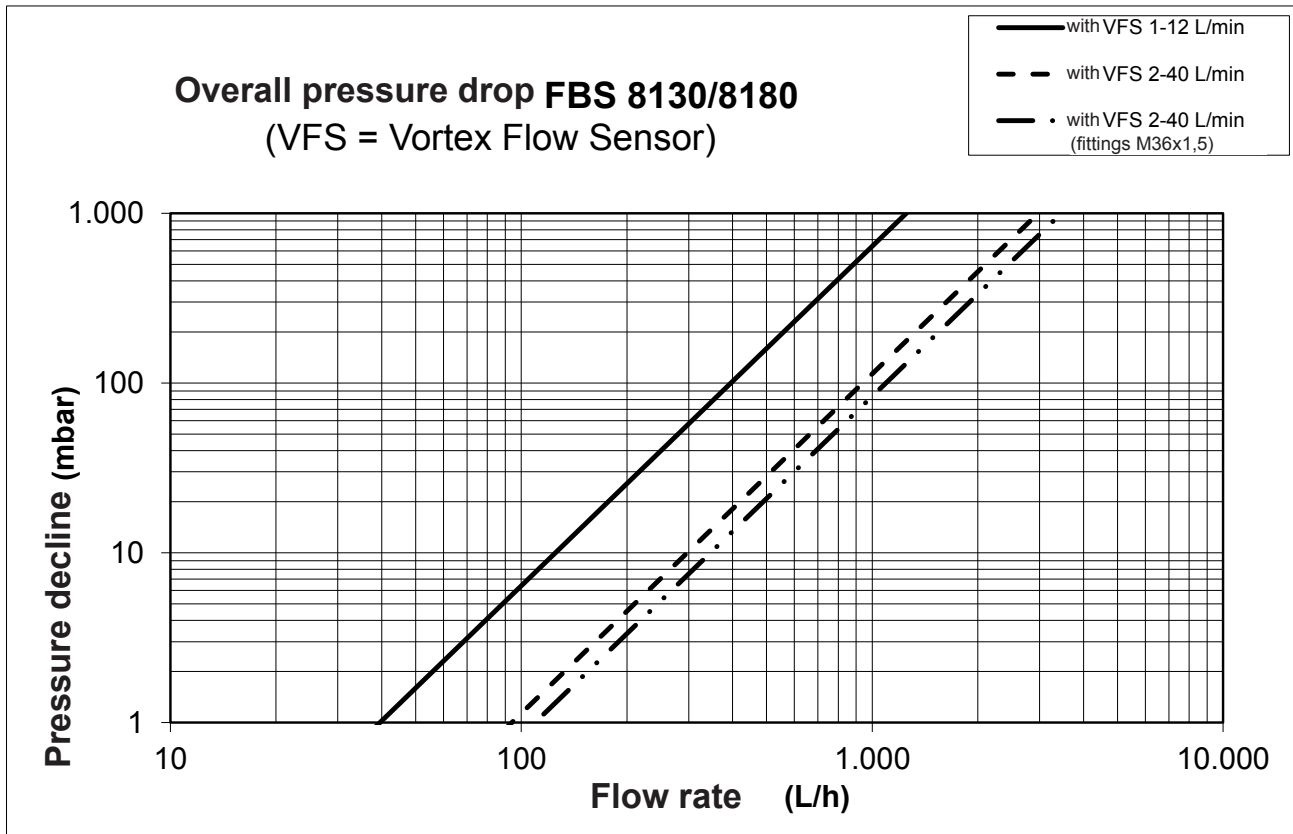

7 Decommissioning, recommissioning

7.1 Decommissioning

- Disconnect the energy supply to the solar station and ensure it cannot be switched back on.

DANGER



Electrical energy!

Risk of death from electric shock.

- Do not touch live cables or components with wet hands.
- Be aware of health and safety regulations when handling electric current.
- Disconnect the energy supply to the solar station and ensure it cannot be switched back on before carrying out any maintenance, cleaning or repair work.

- Remove the front cover on the solar station (see Fig. 4 on page 10).
- Close all shut-off cocks for the water connections.

In the event of prolonged periods of non-use:

- Depressurise the solar station (for example by opening the ventilation screws (Pos. H, see Fig. 7 on page 12).

NOTICE



During the depressurisation process of the solar station, water can leak out.

7.2 Recommissioning

- Slowly open all of the shut-off cocks for the water connections.
- Prime the solar station slowly with pressure and vent it if necessary.
- Restore the power supply to the solar station.

8 Dismantling

Dismantling can be performed for two reasons:

- In order to reassemble the device elsewhere.
- In order to dispose of the device.

NOTICE



If the solar station is to be reassembled elsewhere, the dismantling process must be prepared properly. All installation and fastening parts must be carefully dismantled, labelled and, if necessary, packaged for transportation. This will ensure that, upon reassembly, all the parts can be correctly assigned and fitted back in the appropriate place.

9 Disposal

9.1 Safety

WARNING



Incorrect disposal pollutes the environment and the groundwater!

- When disposing of system parts and operating materials, the regulations and guidelines set down by the legislator of the respective country must be observed.

9.2 Disposal

- Separate the components of the solar station into recyclable materials, hazardous materials and operating materials.
- Dispose of the solar station components or recycle them.

Solar station

