

Kleinstellantrieb
Small servo drive
Petit actionneur
Servomotor pequeño
Regelaandrijving
Mini-attuatore
Inställningsventil
Ovládací náhon ventilu
Zawór nastawczy
малый сервопривод
Mini szelepmeghajtó

de Montagehinweis
 en Mounting instructions
 fr Instructions de montage
 es Indicaciones de montaje
 nl Montage-instructie
 it Istruzioni di montaggio
 sv Montageanvisning
 cs Pokyny pro montáž
 pl Instrukcja montażu
 ru Указание по монтажу
 hu Szerelési útmutató

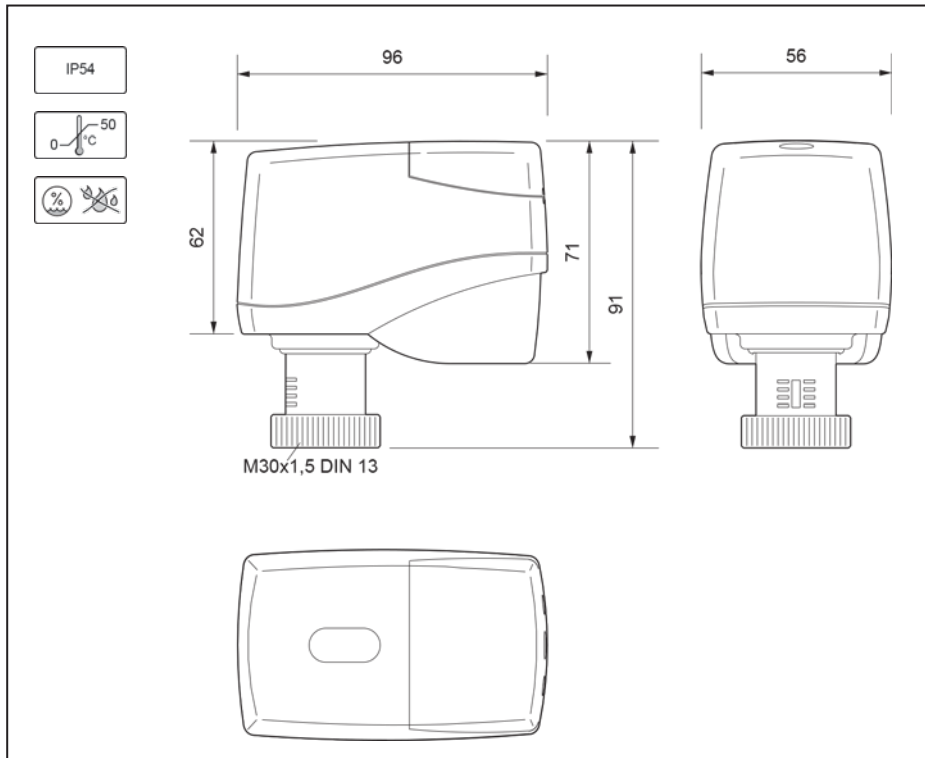
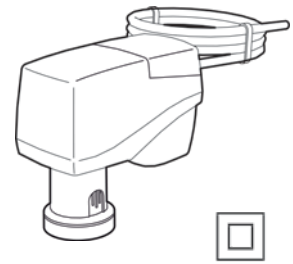

GEFAHR! Elektrische Spannung 230V.

DANGER! Electrical voltage 230V.

DANGER! Tension électrique 230V.

¡PELIGRO! Tensión eléctrica 230V.

GEVAAR! Elektrische spanning 230V.

PERICOLO! Tensione elettrica 230V.

FARA! Elektrisk spänning 230V.

NEBEZPEČÍ! Elektrické napětí 230V.

NIEBEZPIECZEŃSTWO! Napięcie elektryczne 230V.

ОПАСНОСТЬ! Электрическое напряжение 230В.

VESZÉLY! Elektromos feszültség 230V.



ACHTUNG! Montage und Installation darf nur durch qualifiziertes Fachpersonal vorgenommen werden.

NOTICE! Assembly and installation may only be carried out by qualified specialist personnel.

ATTENTION! Le montage et l'installation doivent uniquement être effectués par du personnel qualifié.

¡ATENCIÓN! El montaje y la instalación sólo lo puede realizar personal técnico calificado.

LET OP! Montage en installatie mogen slechts door geschoold personeel met de nodige kwalificatie worden uit- gevoerd.

ATTENZIONE! Fare svolgere i lavori di montaggio e installazione solo da personale qualificato.

VARNING! Montage och installation får endast ske av kvalificerad fackpersonal.

POZOR! Montáž a instalaci smí provádět pouze kvalifikovaný odborný personál.

UWAGA! Montaż i instalację mogą przeprowadzać tylko wykwalifikowani specjaliści.

ВНИМАНИЕ! Монтаж и установка должны производиться только квалифицированным техперсоналом.

FIGYELEM! A szerelést és telepítést csak szakképzett személyek végezhetik.

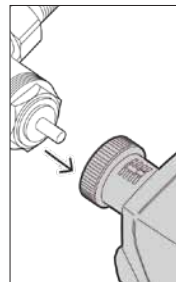
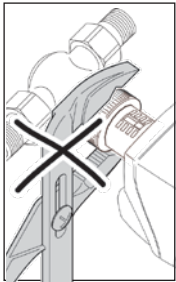
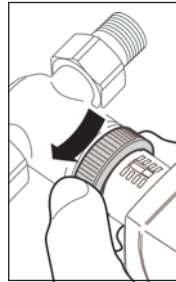
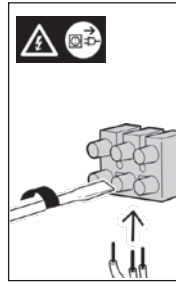
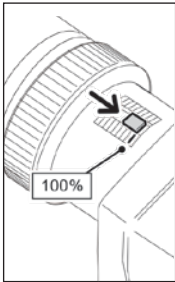
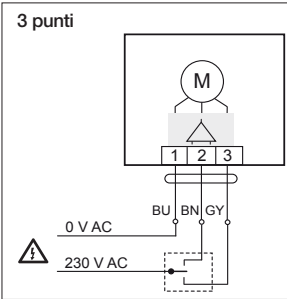
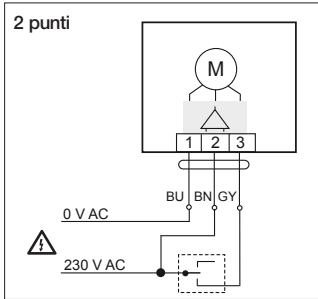
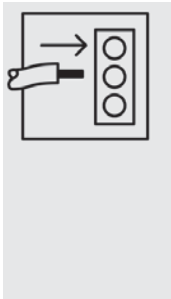
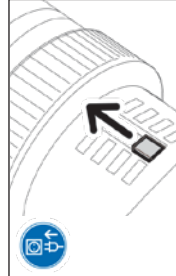
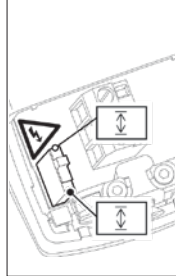
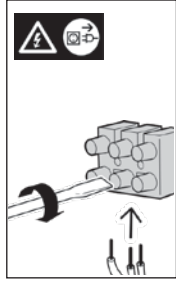
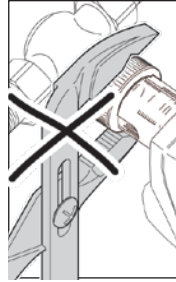
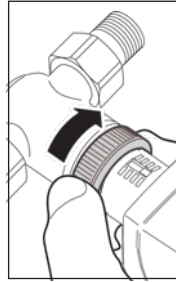
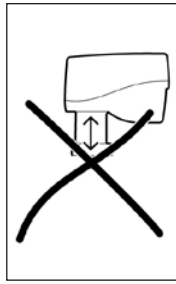
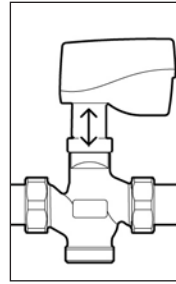
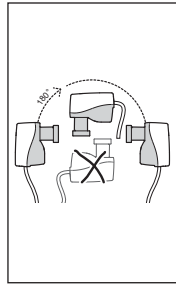
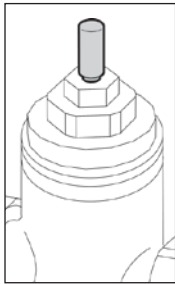
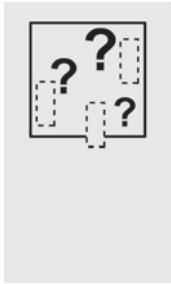

The descriptions and photographs contained in this product specification sheet are supplied by way of information only and are not binding. Watts Industries reserves the right to carry out any technical and design improvements to its products without prior notice." Warranty: All sales and contracts for sale are expressly conditioned on the buyer's assent to Watts terms and conditions found on its website at www.wattswater.eu. Watts hereby objects to any term, different from or additional to Watts terms, contained in any buyer communication in any form, unless agreed to in a writing signed by an officer of Watts.



Watts Industries Italia S.r.l.

Sede operativa: Via Brenno, 21 - 20853 Biassono (MB), Italia - Tel: +39 039 49.86.1 - Fax: +39 039 49.86.222

Sede legale: Frazione Gardolo, Via Vienna, 3 - 38121 Trento (TN), Italia - Cod. Fisc. 00743720153 - Partita IVA n° IT 01742290214

Società unipersonale del gruppo Watts Italy Holding Srl - soggetta a direzione e coordinamento ai sensi degli artt. 2497 e s.m.i. del C.C.