

MMV-S

Thermostatic mixing valve for solar systems

Technical data sheet



Description

The MMV-S thermostatic mixing valve has been specially designed for systems with high flow rates and operates without interruption at high solar water temperatures.

- Easy to install
- Wax technology element for temperatures up to 110°C
- Handwheel with set positions (graduated scale Min to Max - 5 setting positions)
- Lockable cap with hex screw
- Excellent stability of the mixed water temperature
- Robust and simple construction ensures reliability, longevity and safety.
- Corrosion resistant DZR brass body
- Built-in safety device in case of interruption of cold or hot water (mixing valve cut-off with residual flow)
- Can be installed in any position
- Nickel-plated or self-colour finish
- PTFE inner coating designed to prevent scale build-up
- Sanitary Conformity Certificate (ACS)

Technical features

Technical features	
Maximum static pressure	10 bar
Maximum dynamic pressure	6 bar
Operating pressure	0,2 to 5 bar
Hot temperature supply *	52°C – 110°C
Cold temperature supply *	5°C – 25°C
Temperature setting range	30°C / 65°C (Factory pre-set at 50°C in mixed water)
Accuracy of mixed water temperature	±2°C between 45 and 65°C (with balanced dynamic pressures)
Flow rate at 3 bar	63 l/min
Flow mini	5 l/min

* differential minimum hot/mix temperature must be 10°C.

Part number



Part number	Body	Connections	Flow	Setting range	Weight
Without check valve*, self-colour brass finish					
2297500	DN25	union M/M/M 1/2"	63 l/min	30/65°C	0,700 kg
2297501	DN25	union M/M/M 3/4"	63 l/min	30/65°C	0,756 kg
2297560	DN25	M/M/M 1"	63 l/min	30/65°C	0,391 kg
Without check valve*, nickel finish					
2297530	DN25	union M/M/M 1/2"	63 l/min	30/65°C	0,712 kg
2297531	DN25	union M/M/M 3/4"	63 l/min	30/65°C	0,765 kg
2297561	DN25	M/M/M 1"	63 l/min	30/65°C	0,395 kg
With check valve, self-colour brass finish - Max temp.: 65°C/85°C 1h max. in the event of an accidental peak					
2297534	DN25	union M/M/M 3/4"	63 l/min	30/65°C	0,756 kg
2297564	DN25	M/M/M 1"	63 l/min	30/65°C	0,386 kg
With check valve, nickel finish - Max temp.: 65°C/85°C 1h max. in the event of an accidental peak					
2297532	DN25	union M/M/M 1/2"	63 l/min	30/65°C	0,756 kg
2297533	DN25	union M/M/M 3/4"	63 l/min	30/65°C	0,700 kg
2297562	DN25	M/M/M 1"	63 l/min	30/65°C	0,395 kg

* Provide for the installation of check valves at the hot and cold water inlets.

Nomenclature and materials

N°	Designation	Materials	EURO
1	Body	DZR anticorrosion brass	CW625N
	Finish	Nickel plated or self-colour brass	
2	Spring	Stainless steel	1.4310 (AISI 301/302)
	Others brass parts		CW617N-4MS
3	Piston	Brass	CW602N
	Inner coating	Plastic	PTFE
4	Check valve 1"	POM + stainless steel + rubber	
5	O-ring	EPDM & NBR	
6	Cap	PA	Grivory HT1V-4XFWA black 9225 (PPA)

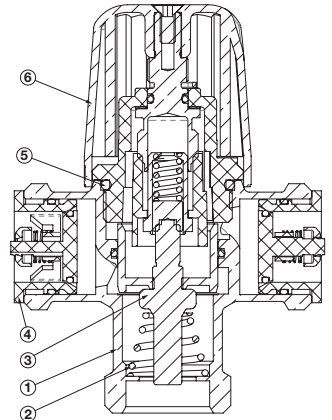

Application

MMV-S Series thermostatic mixing valves are used in solar energy systems for the production of domestic hot water.

In these systems the temperature of the water in the storage tank can vary considerably depending on the season and the degree of solar radiation, and can reach very high temperatures over long periods.

Especially in summer, and if there is little water usage, the hot water at the storage tank outlet can reach temperatures of around 95°C before the safety valve is actuated, and at these temperatures, hot water cannot be used for domestic purposes

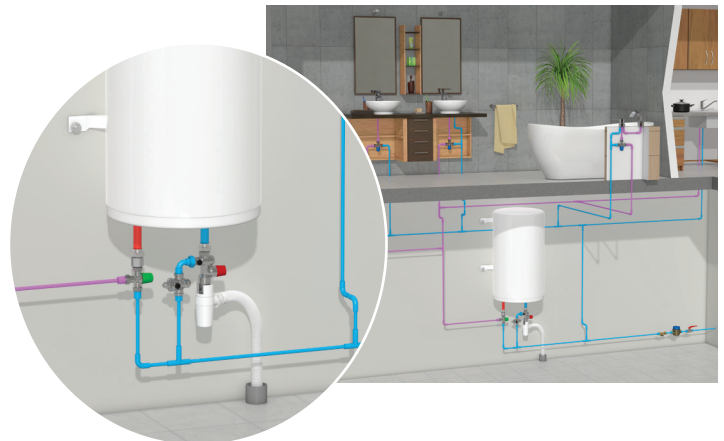

Installation

Install MMV-S Series thermostatic mixing valves as shown in the diagram below.

Their installation must comply with the rules of the trade, D.T.U. and all other rules in force applicable to the place of installation.

They can be installed in any position, both vertically and horizontally.

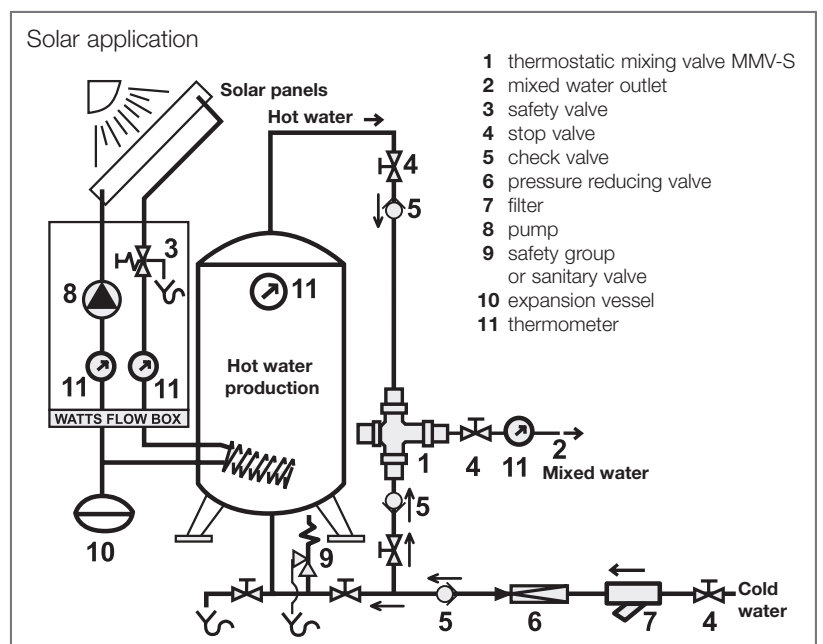

Setting

To maintain the performance of the mixing valve, a filter must be installed upstream of the main water supply. The thermostatic mixing valve is supplied factory pre-set at 50°C. However, installation conditions will dictate, that the product be adjust on site. With both hot and cold supplies turned fully on and the terminal fitting open, adjust the temperature to the required setting. To adjust the temperature, simply unscrew the locking screw on the top of the cap, set the valves and lock with the screw:

- To increase the temperature, turn anti-clockwise.
- To decrease the temperature, turn clockwise.

The temperature and pressures must be stabilized and checked before commissioning (allow mixed water to flow for 1 minute prior final setting).

All parameters must be in accordance with the technical specifications of the valve.

After final adjustment, replace the cap to lock the valve in position and prevent tampering.

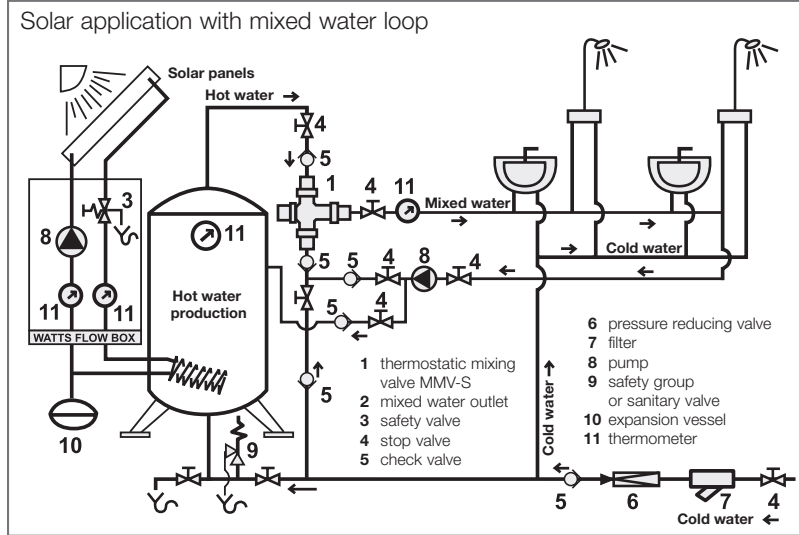

Sizing (mm)

Connection union 1/2"

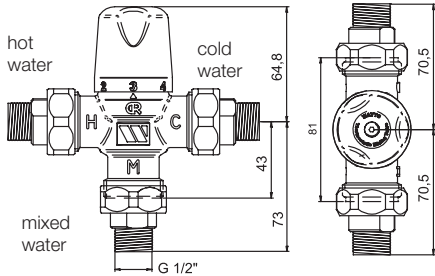

Connection union 3/4"

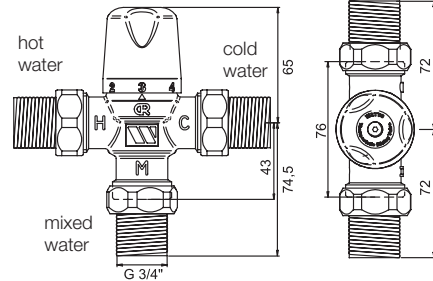

Thread 1"

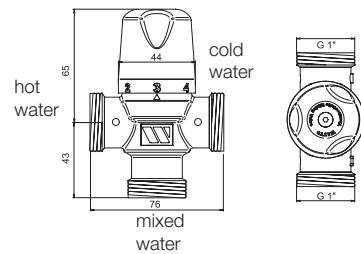

Operating

Headloss chart

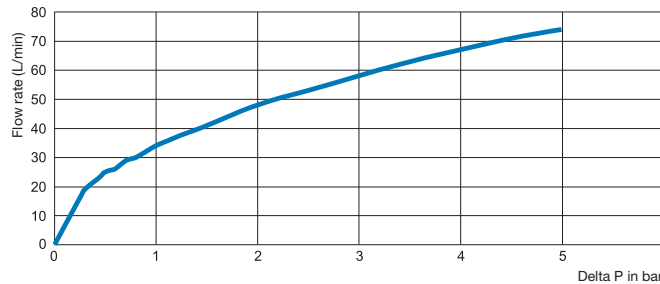

Factory pre-set at 50°C.

The descriptions and photographs contained in this product specification sheet are supplied by way of information only and are not binding. Watts reserves the right to carry out any technical and design improvements to its products without prior notice. Warranty : All sales and contracts for sale are expressly conditioned on the buyer's assent to Watts terms and conditions found on its website at www.watts.com. Watts hereby objects to any term, different from or additional to Watts terms, contained in any buyer communication in any form, unless agreed to in a writing signed by an officer of Watts.



WATTS INDUSTRIES France
1590 avenue d'Orange • CS 10101 Sorgues 84275 VEDENE CEDEX • FRANCE
Tél. +33 (0)4 90 33 28 28 • Fax +33 (0)4 90 33 28 29/39
contact@wattswater.com • www.wattswater.eu