

# FlowBox DN20

Pump and pump mixer groups DN20

## VB20

Boiler manifolds DN20

### Technical Data Sheet



## Description

The pump groups FlowBox DN20 represent a complete ready-to-install assembly with thermal insulation, containing all necessary components (pump, shut-off and mixing valves, thermometers, check valves, pipes) for installation in a heating system. For models supplied without the pump unit, the pump is to be selected by the installer or heating engineer(s).



### FlowBox HK20

Compact pump group for direct heating circuits. 3-part patented EPP insulation shell provides a thermal insulation according to GEG (German Buildings Energy Act). Easy wall mounting with only one screw. Incl. wall bracket and fastening. 2 integrated temperature sensor connectors.

**Supply:** shut-off valve with gravity brake and integrated thermometer 0-120 °C, circulation pump 130 mm, additional shut-off valve under the pump (HK20-KH only).

**Return:** shut-off valve with integrated thermometer 0-120 °C. Return pipe made of stainless steel.

Typ	Part no.	Version	Weight
HK20-KH	10084151	Wilo Para SC15/6, with additional shut-off valve	4.1 kg
HK20-KH	10077143	Grundfos UPM3A/7, with additional shut-off valve	4.1 kg
HK20-KH	10087347	Lowara Eco2/8, mit zusätzlichem Kugelhahn	-
HK20-KH	10086223	KSB CalioSI/7, with additional shut-off valve	5.1 kg
HK20-KH	10077144	without pump, with additional shut-off valve	2.4 kg
HK20	10084150	Wilo Para SC15/6	3.9 kg
HK20	10080551	Grundfos UPM3A/7	4.0 kg
HK20	10087346	Lowara Eco2/8	-
HK20	10080550	without pump	2.1 kg



### FlowBox HKM20

Compact pump and mixer group for mixed heating circuits. 3-part patented EPP insulation shell provides a thermal insulation according to GEG (German Buildings Energy Act). Easy wall mounting with only one screw. Incl. wall bracket and fastening. 2 integrated temperature sensor connectors.

**Supply:** shut-off valve with gravity brake and integrated thermometer 0-120 °C, circulation pump (130 mm), 3-way mixer and motor.

**Return:** shut-off valve with integrated thermometer 0-120 °C. Return pipe made of stainless steel. The flow and return pipes of FlowBox HKM20 are interchangeable from left to the right side.

Typ	Part no.	Kvs	Version	Weight
HKM20 4.0	10084149	4.0	Wilo Para SC15/6	4.6 kg
HKM20 4.0	10077146	4.0	Grundfos UPM3A/7	4.6 kg
HKM20 4,0	10087348	4,0	Lowara Eco2/8	-
HKM20 4,0	10086222	4.0	KSB CalioSI/7	4.6 kg
HKM20 4.0	10077147	4.0	without pump	2.7 kg
HKM20 6.3	10084148	6.3	Wilo Para SC15/6	4.6 kg
HKM20 6.3	10080077	6.3	Grundfos UPM3A/7	4.6 kg
HKM20 6,3	10087349	6,3	Lowara Eco2/8	-
HKM20 6,3	10086221	6.3	KSB CalioSI/7	4.6 kg
HKM20 6.3	10080076	6.3	without pump	2.9 kg

## FlowBox HKF20



Compact pump and mixer group for mixed heating circuits with thermostatic fixed temperature control. Setting range: 20-55 °C or 30-70 °C. 3-part patented EPP insulation shell provides a thermal insulation according to GEG (German Buildings Energy Act). Easy wall mounting with only one screw. Incl. wall bracket and fastening. 2 integrated temperature sensor connectors.

**Supply:** shut-off valve with gravity brake and integrated thermometer 0-120 °C, circulation pump 130 mm, 3-way thermostatic mixing valve.

**Return:** shut-off valve with integrated thermometer 0-120 °C. Return pipe made of stainless steel. The flow and return pipes of FlowBox HKF20 are interchangeable from left to the right side.

Typ	Part no.	Setting range	Version	Weight
HKF20	10084591	20 - 55 °C	Wilo Para SC15/6	5.1 kg
HKF20	10084592	20 - 55 °C	Grundfos UPM3A/7	5.1 kg
HKF20	10087350	20 - 55 °C	Lowara Eco2/8	-
HKF20	10086875	20 - 55 °C	KSB CalioSI/7	6.1 kg
HKF20	10084593	20 - 55 °C	without pump	2.9 kg
HKF20	10084594	30 - 70 °C	Wilo Para SC15/6	5.1 kg
HKF20	10084595	30 - 70 °C	Grundfos UPM3A/7	5.1 kg
HKF20	10087351	30 - 70 °C	Lowara Eco2/8	-
HKF20	10086876	30 - 70 °C	KSB CalioSI/7	6.1 kg
HKF20	10084596	30 - 70 °C	without pump	2.9 kg

## FlowBox HKFC20



Compact pump and mixer group for mixed heating circuits with electrical fixed temperature control. Setting range: 5-95 °C<sup>1)</sup>. 3-part patented EPP insulation shell provides a thermal insulation according to GEG (German Buildings Energy Act). Easy wall mounting with only one screw. Incl. wall bracket and fastening. 2 integrated temperature sensor connectors.

**Supply:** shut-off valve with gravity brake and integrated thermometer 0-120 °C, circulation pump 130 mm, 3-way mixing valve, motor incl controller.

**Return:** shut-off valve with integrated thermometer 0-120 °C. Return pipe made of stainless steel. The flow and return pipes of FlowBox HKFC20 are interchangeable from left to the right side.

Typ	Part no.	Setting range	Version	Weight
HKFC20	10084147	5 - 95 °C <sup>1)</sup>	Wilo Para SC15/6	4.7 kg
HKFC20	10080553	5 - 95 °C <sup>1)</sup>	Grundfos UPM3A/7	4.7 kg
HKFC20	10087352	5 - 95 °C <sup>1)</sup>	Lowara Eco2/8	-
HKFC20	10086848	5 - 95 °C <sup>1)</sup>	KSB CalioSI/7	5.7 kg
HKFC20	10080552	5 - 95 °C <sup>1)</sup>	without pump	2.9 kg

1) Note the maximum operating temperature of the circulation pump!

## VB20



Boiler manifold for the connection of 2 or 3 pump groups FlowBox DN20.

Connection to pump groups: 1" UN; connection to the installation: 1" M. Thermal insulation by EPP insulation shell with thermal separation of supply and return chamber. Suitable wall-mount bracket WH-VB20/25/32 available as accessory.

Typ	Part no.	Version	Weight
VB20-2	10077395	for connection of 2 pump groups	3.9 kg
VB20-3	10077396	for connection of 3 pump groups	6.2 kg
WH-VB20/25/32	10026388	wall brackets for VB20 and VB25/32	0.29 kg

## Technical data pump groups

Hydraulic performance data		Pump groups FlowBox DN20				
Max. operating pressure	6 bar					
Ambient temperature	-10 °C to +40 °C (note pump specification!)					
Operating temperature	+2 °C to +90 °C (note pump specification!)					
Recommended range of application (at $\Delta T=20$ K, $\Delta p=100$ mbar)	HK20	HKM20	HKM20	HKF20	HKFC20	
	max. 55 kW	max. 24 kW	max. 48 kW	max. 20 kW	max. 48 kW	
Kvs-values		4.0	6.3	3.4	6.3	
Opening pressure of gravity brake	10 mbar					
Thermometer display range	0 - 120 °C					
Nominal size	DN20					
Media	Water or water-glycol mixes as per VDI (Association of German Engineers) 2035 / ÖNORM (Austrian standard) H 5195					
Power supply connection						
Supply voltage	See separate pump and actuator documentation					
Dimensions						
W × H × D with insulation shell	240 × 310 × 217 mm					
Axial distance	90 mm					
Distance between sealing surfaces	293 mm					
Weight	packing excluded		packing included			
	see description tables		approx. 0.4 kg more than net weight			
Piping connections						
1" male thread, flat sealing						
Materials						
Return pipes	stainless steel Ø 33 mm					
Valves / fittings / connecting pipe	brass CW617N					
Gaskets	AFM34/2					
Insulation shell	EPP					
Gravity brake	POM, NBR, stainless steel					
Plastics	Impact- and temperature-resistant					
O-rings	EPDM					
Bracket	Spring steel					
Wall brackets	Steel plate, zinc-plated					
Tightening torques for screw connections						
¾": 35 Nm; 1": 55 Nm						
Circulation pumps and motors						
See product-specific documentation for technical data of circulating pumps.						

## Technical data boiler manifolds

Hydraulic performance data	VB20-2	VB20-3
Max. operating pressure	6 bar	
Operating temperature	+2 °C to 110 °C	
Power	max. 38 kW (V=1m/s and ΔT=20K)	
Media	Water or water-glycol mixes as per VDI (Association of German Engineers) 2035 / ÖNORM (Austrian standard) H 5195	
Kvs value, 1 open output	11	11
Kvs value, 2 open outputs	14	13.5
Kvs value, 3 open outputs	-	15.5
Nominal size	DN20	
Dimensions		
Dimensions (W × H × D with insulation)	481 × 135.5 × 217 mm	722 × 135.5 × 217 mm
Weight		
packing excluded	3.9 kg	6.3 kg
packing included	4.3 kg	6.7 kg
Connections		
to heating circuit	1" union nut with flat sealing	
to boiler	1" male thread with flas sealing	
Materials		
Manifold	steel pipe	
Union nut / sealing cap	brass CW617N	
Flat gaskets	AFM34/2	
Insulation shell	EPP	
Tightening torques for screw connections		
1"	55 Nm	

## Charts

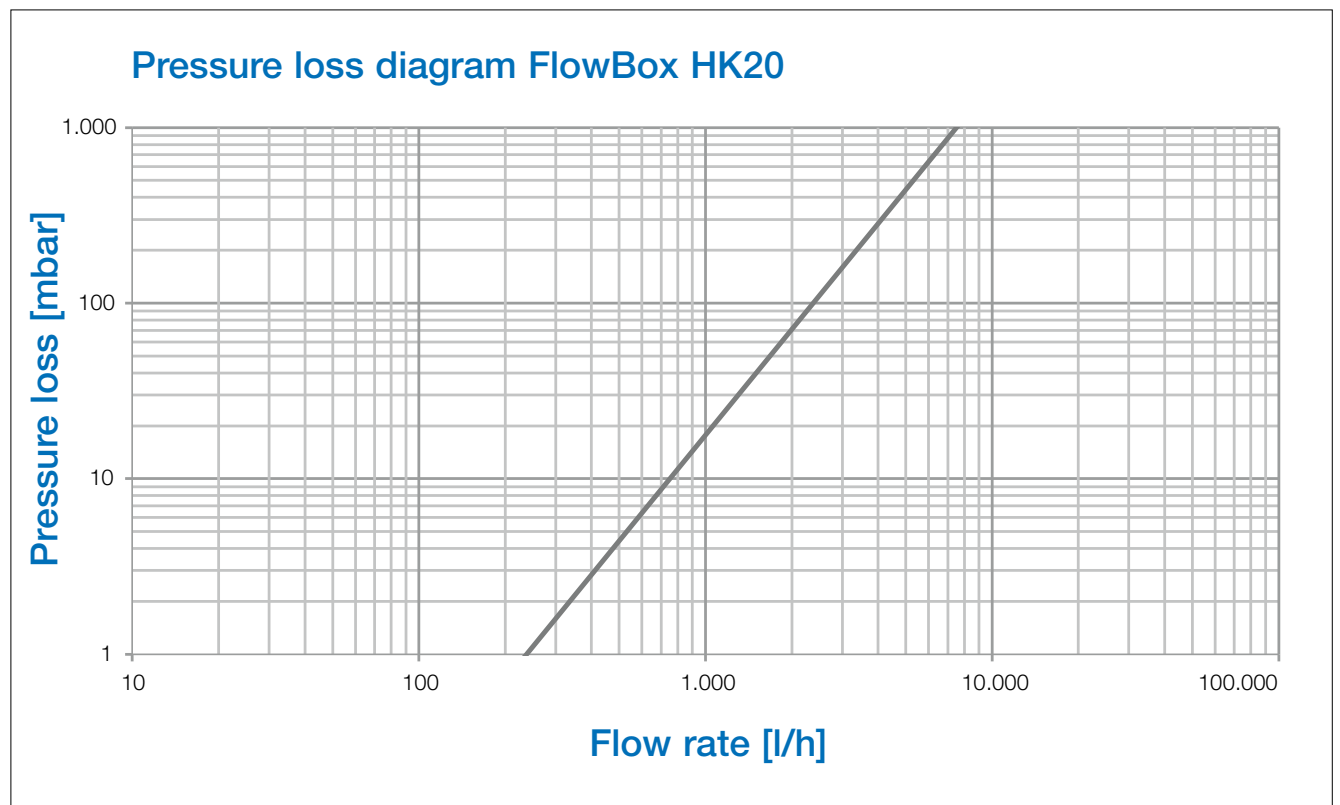

Pressure loss diagram FlowBox HKM20 and HKFC20

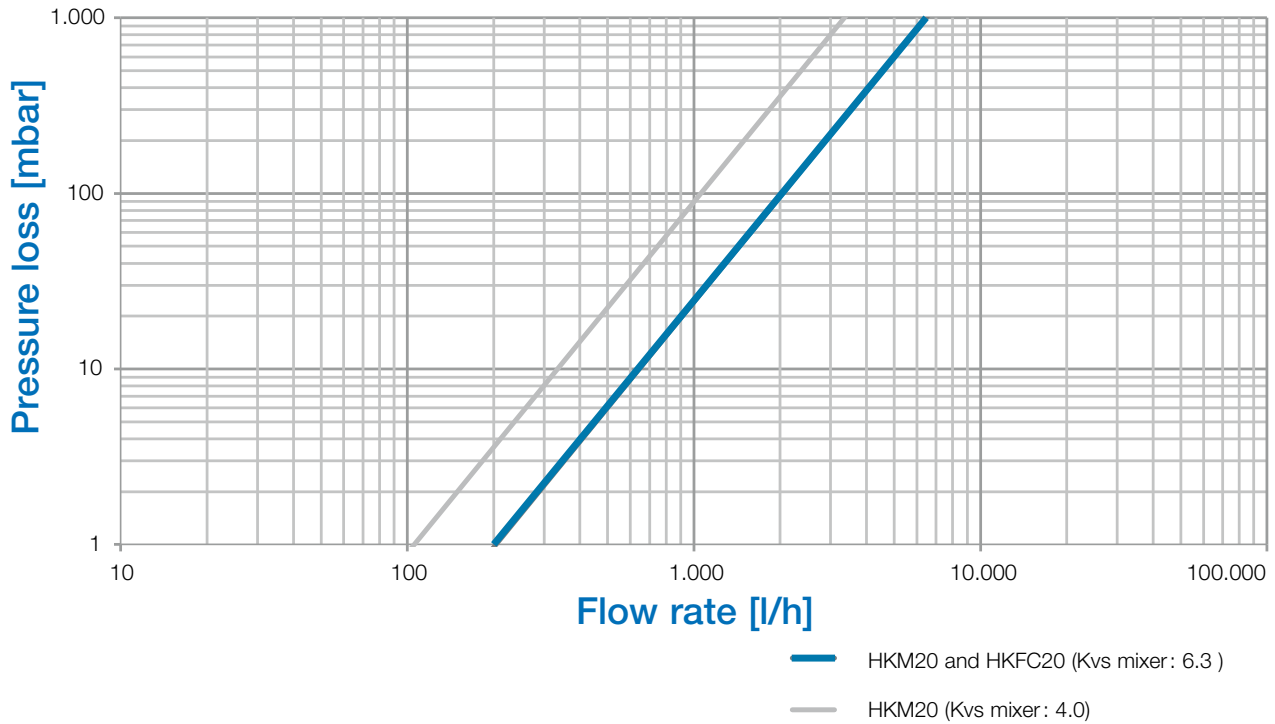

Pressure loss diagram FlowBox HKF20

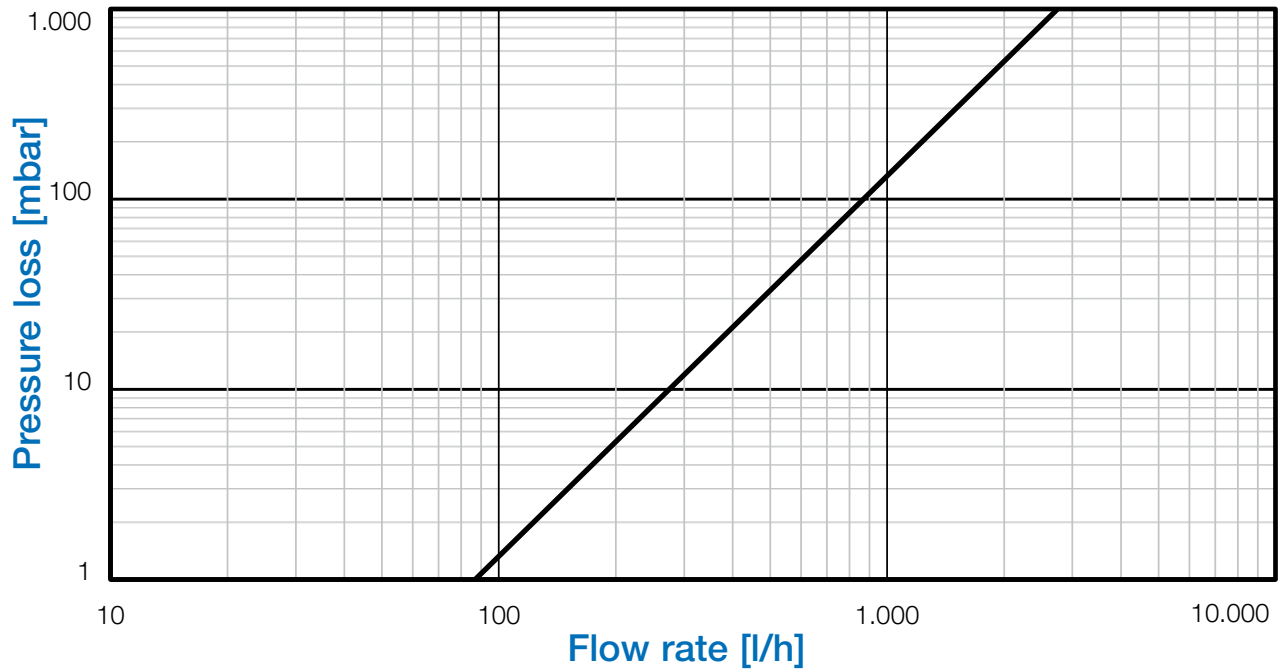

Pressure loss diagram VB20-2

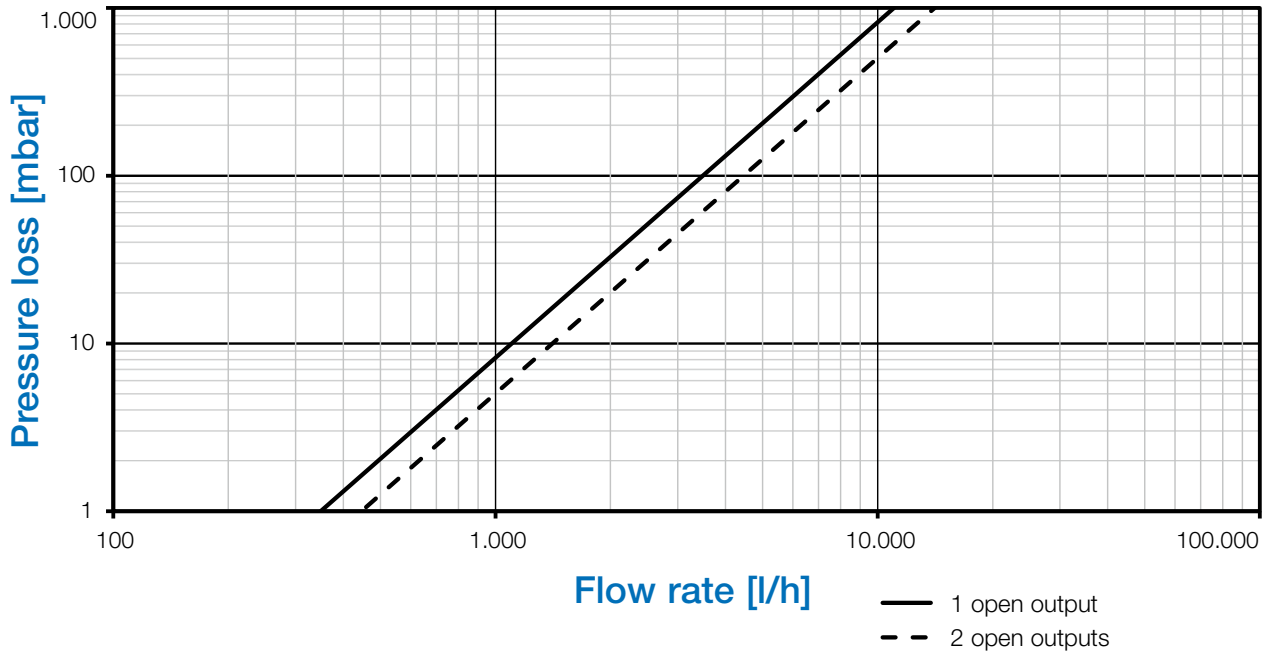

Pressure loss diagram VB20-3

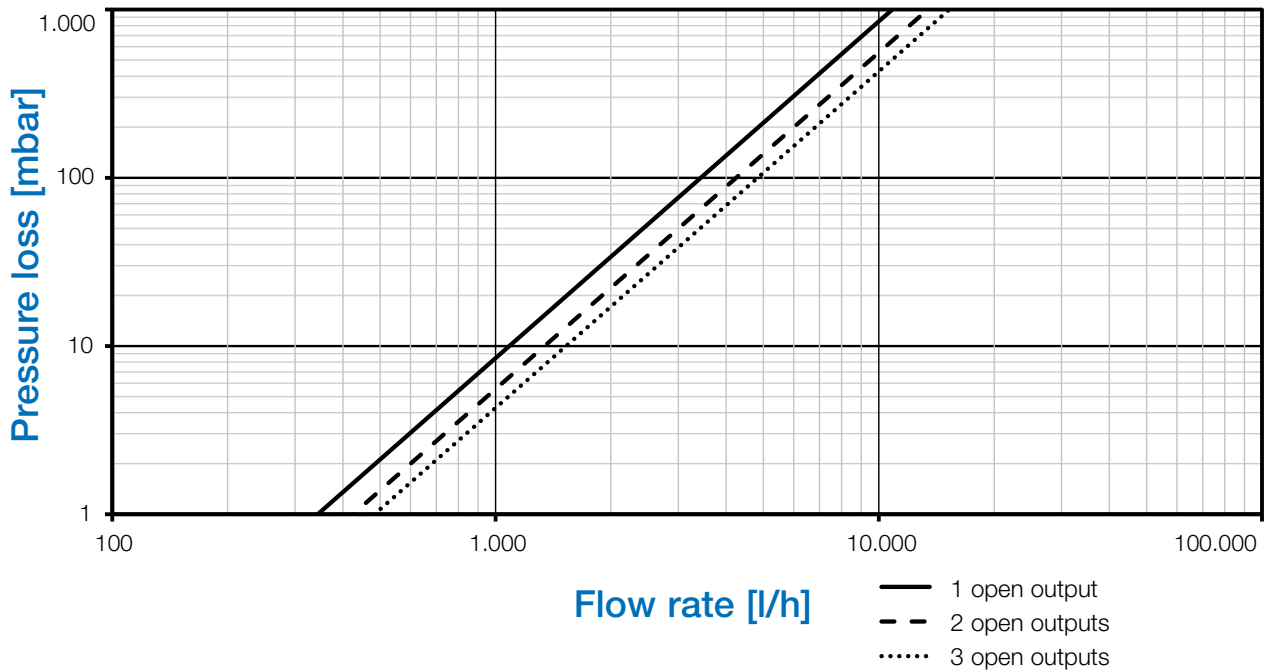

## Construction

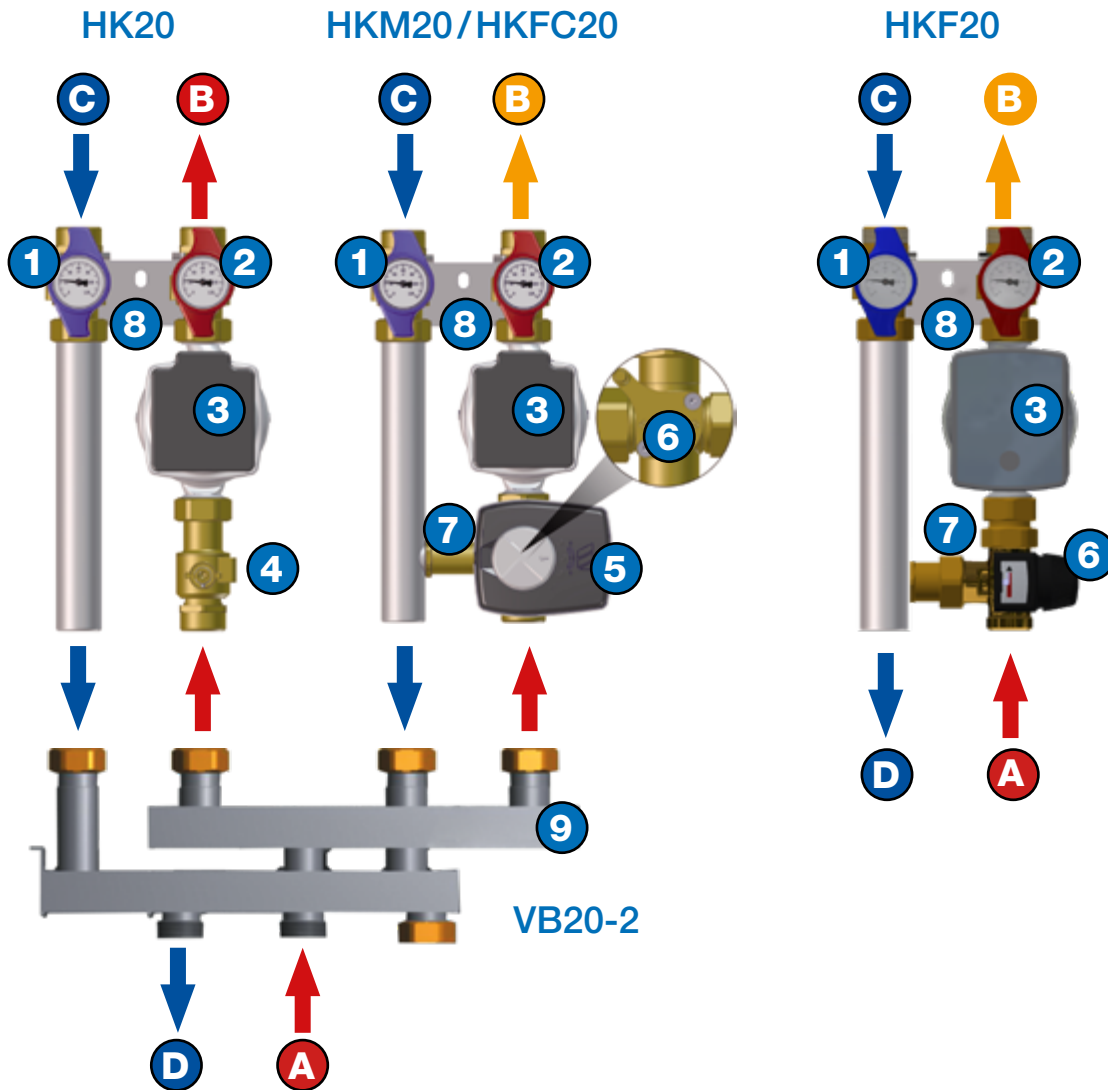

- |   |  |   |                                 |
|---|--|---|---------------------------------|
| 1 | Shut off valve (return line)                                     | A | Supply inlet (boiler circuit)   |
| 2 | Shut off valve with gravity brake (supply)                       | B | Supply outlet (heating circuit) |
| 3 | Circulation pump   | C | Return inlet (heating circuit)  |
| 4 | Additional shut-off valve (only HK-KH)                           | D | Return outlet (boiler circuit)  |
| 5 | Motor (HKM20)<br>Motor with controller (HKFC20)                  |   |                                 |
| 6 | 3-way-mixer (HKM20, HKFC20)<br>Thermostatic mixing valve (HKF20) |   |                                 |
| 7 | Bypass   |   |                                 |
| 8 | Wall brackets  |   |                                 |
| 9 | Boiler manifold VB20-2   |   |                                 |

## Application

The pump groups Watts FlowBox DN20 are used to connect boilers to mixed (HKM20/HKF20/HKFC20) or direct heating circuits (HK20) in the heating systems.

The distribution manifold VB20 allows the installation of 2 or 3 pump groups side by side.



## Installation variants

For maximum flexibility, when connecting additional components to the boiler manifold, two connecting ports for the return line are available to the fitter. The Flowbox and boiler manifold arrangement may be even be entirely reversed if necessary.

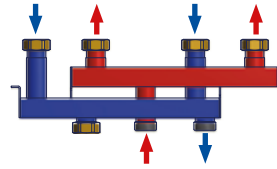

The left return port is closed

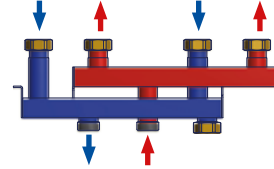

The right return port is closed

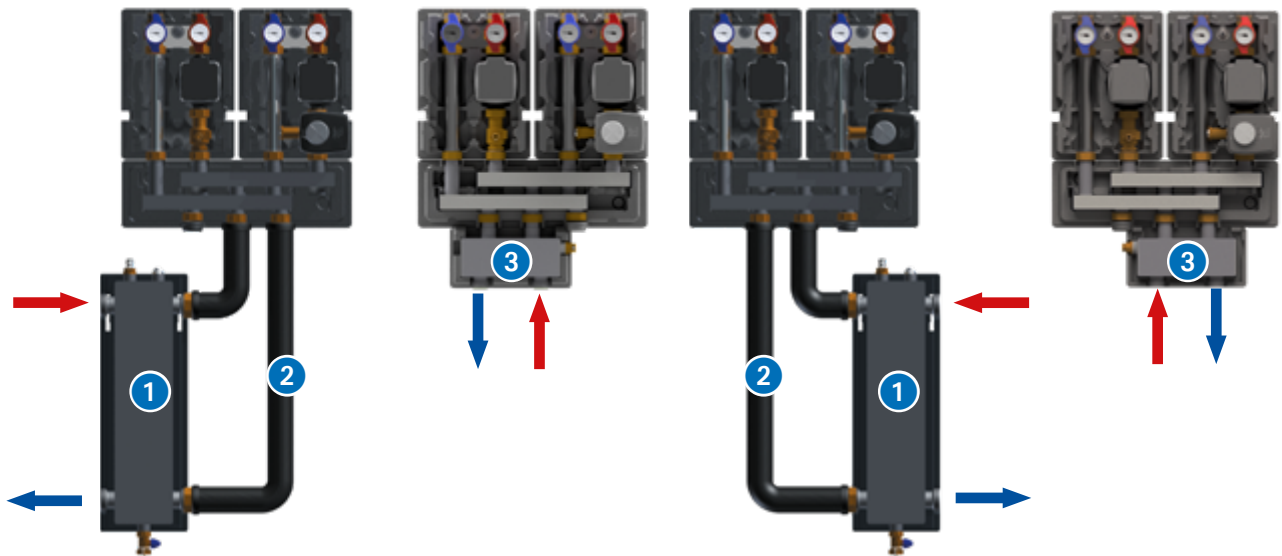

## Hydraulic separators



### HW80/120 and RB-HW80/120-VB20

Compact hydraulic separator with EPP insulation, fill and drain-cock, immersion sleeve 1/2", Di=6.5 mm for thermometer, manual air-vent, screw connections, wall bracket.

RB-HW: connection set consisting of two heat insulated pipes for direct connection of the HW80/120 to pump groups FlowBox DN20 or to distribution manifold VB20.

Typ	Part no.	Version	Weight
HW 80/120	10010376	4 m³/h; 44 kW ( $\Delta t = 10 \text{ K}$ )	6.0 kg
RB-HW 80/120-VB20	10082527	insulated pipe connection set	1.2 kg



### HW-Q20 1"

Compact hydraulic separator with EPP insulation for direct connection to pump groups FlowBox DN20 or to distribution manifold VB20. All connections 1" with flat sealing.

Typ	Part no.	Version	Weight
HW-Q20 1"	10082260	1.1 m³/h; 13.25 kW ( $\Delta t = 10 \text{ K}$ )	2.1 kg

## Insulation

The thermal insulation of the pump groups FlowBox DN20 and distribution manifold VB20 are of uniform design. The patented, three-part insulation shells ensure GEG (German Buildings Energy Act) thermal insulation.

### Rear insulating shell:

- Pre-stamped cable ducts for clean and discreet cable routing in all directions;
- sound protection.



### Manifold insulation shell:

- Supply and return chambers are thermally separated from each other by an insulating shell.

### Middle insulating shell:

- Thermal insulation of the sensitive pump electronics parts from the hydraulic parts of the pump group.



### Front insulation shell:

- Heat and dust protection
- Ventilation of pump electronics through slots in the shell at the top and bottom the bowl.



## Installation with interchanged flow and return

The pump groups are supplied with flow on the right side. The return and flow of the mixer groups HKM20, HKF20 and HKFC20 can be interchanged in a few steps (see operating instructions). For mounting on boiler manifold, the latter must be turned 180° (as shown below).

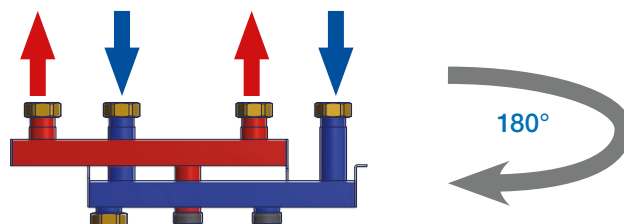
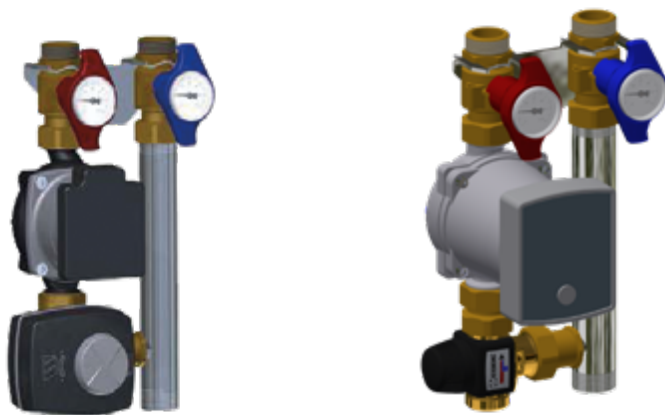

## Integrated temperature sensor connector

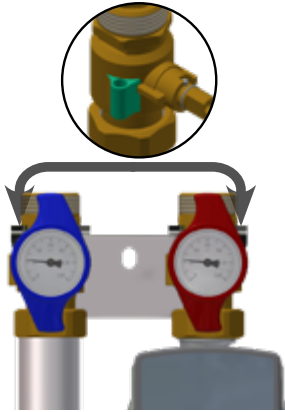

All pump groups FlowBox DN20 are equipped with 2 immersion sleeves (in the flow and return) for easy connection of the temperature sensors.

### Dimensions [mm]

#### Pump groups FlowBox DN20 and Verteilerbalken VB20

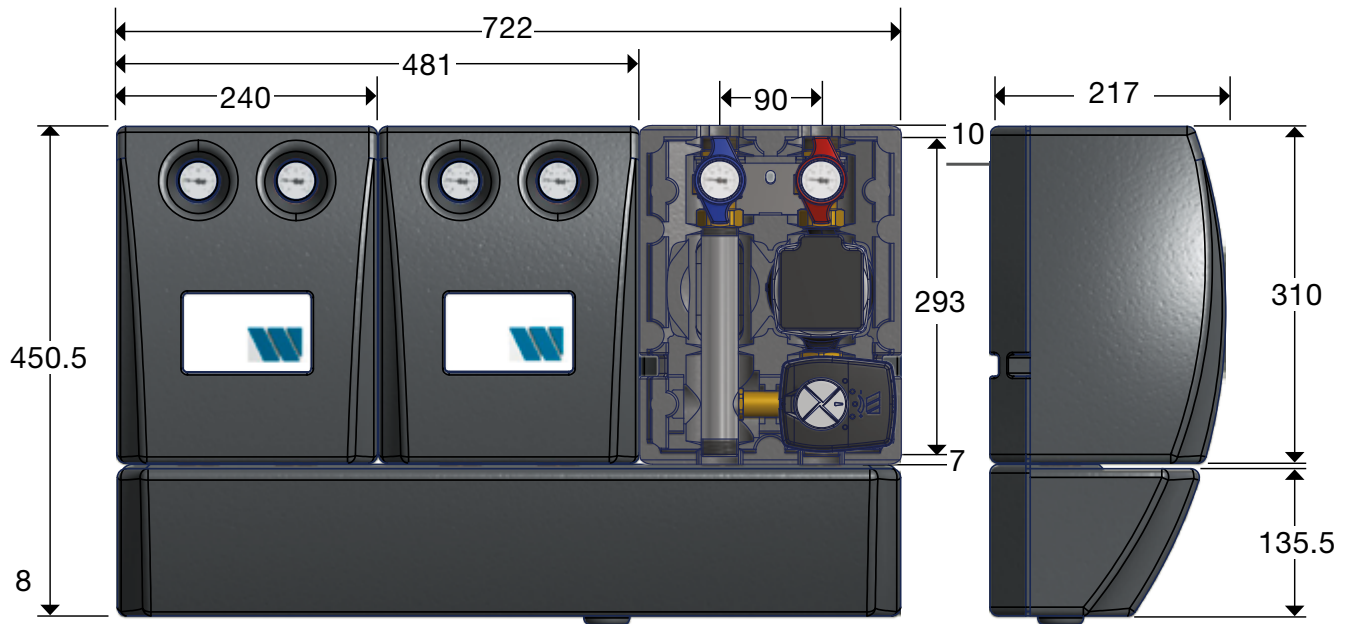

#### HW80/120 and RB-HW80/120-VB20 HW-Q60/80

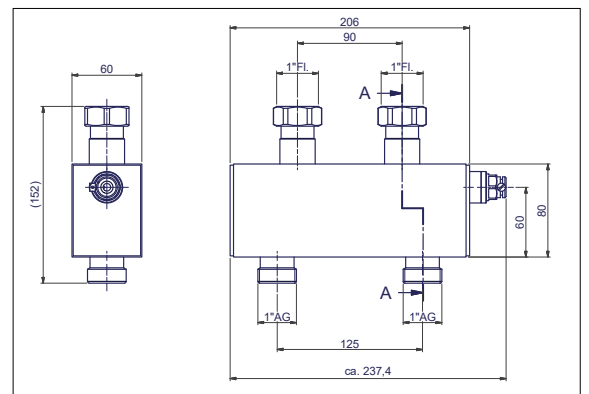
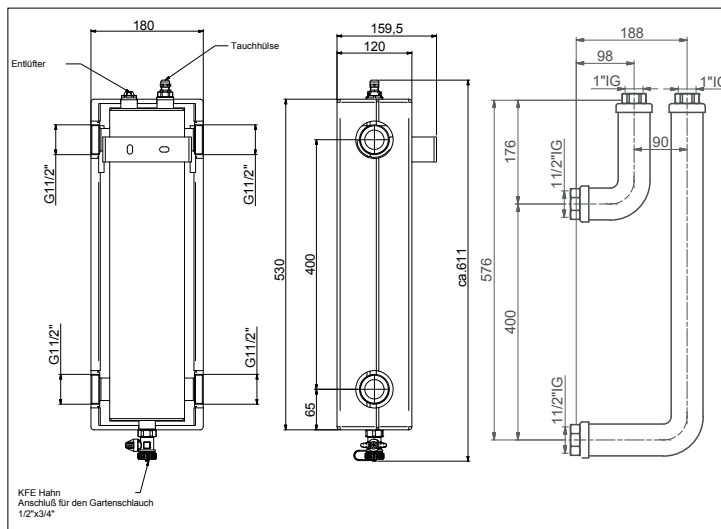

## Product texts

### **FlowBox HK20**

Pump group for connecting boilers to unmixed heating circuits. Space-saving design with a pump length of 130 mm and an axial distance of 90 mm. All Watts pump groups and boiler manifolds are of uniform design. A patented EPP insulation shell provides a highly effective heat insulation conforming to GEG (German Buildings Energy Act). Simple installation by means of a wall-mount bracket. Concealed cable routing behind insulation. All connections G1" male thread, flat sealing. 2 multifunctional shut-off valves with thermometer (0-120 °C) and integrated temperature sensor connector, adjustable gravity brake in the flow. For operation in closed heating networks with non-aggressive media, such as water or water-glycol mixes as per VDI (Association of German Engineers) 2035/ÖNORM (Austrian standard) H 5195.

### **FlowBox HKM20**

Pump and mixer groups for connecting boilers to mixed heating circuits. Space-saving design, pump length of 130 mm and an axial distance of 90 mm. Simple conversion from right to left. All Watts pump groups and boiler manifolds are of uniform design. Newly developed 3-way mixing valve (protected design) with very few single parts and sealing sur-faces; easily switchable from right to left; actuator can be integrated in several directions. A patented EPP insulation shell provides a highly effective heat insulation conforming to GEG (German Buildings Energy Act). Simple installation by means of a wall-mount bracket. Concealed cable routing behind insulation. All connections G1" male thread, flat sealing. 2 multifunctional shut-off valves with thermometer (0-120 °C) and integrated temperature sensor connector, adjustable gravity brake in the flow. 3-way mixer (Kvs 4.0 or Kvs 6.3) with actuator. For operation in closed heating networks with non-aggressive media, such as water or water-glycol mixes as per VDI (Association of German Engineers) 2035/ÖNORM (Austrian standard) H 5195.

### **FlowBox HKF20**

Pump and mixer groups with thermostatic fix point control for connecting boilers to mixed heating circuits. Space-saving design with a pump length of 130 mm and an axial distance of 90 mm. Simple conversion from right to left. All Watts pump groups and boiler manifolds are of uniform design. A patented EPP insulation shell provides a highly effective heat insulation conforming to GEG (German Buildings Energy Act). Simple installation by means of a wall-mount bracket. Concealed cable routing behind insulation. 2 multifunctional shut-off valves with thermometer (0-120 °C) and integrated temperature sensor connector, adjustable gravity brake in the flow. Thermostatic 3-way mixer with setting range: 20-55 °C or 30-70 °C. For operation in closed heating networks with non-aggressive media, such as water or water-glycol mixes as per VDI (Association of German Engineers) 2035/ÖNORM (Austrian standard) H 5195.

### **FlowBox HKFC20**

Pump and mixer groups for connecting boilers to mixed heating circuits. Space-saving design, pump length of 130 mm and an axial distance of 90 mm. Simple conversion from right to left. All Watts pump groups and boiler manifolds are of uniform design. Newly developed 3-way mixing valve (protected design) with very few single parts and sealing sur-faces; easily switchable from right to left; actuator can be integrated in several directions. A patented EPP insulation shell provides a highly effective heat insulation conforming to GEG (German Buildings Energy Act). Simple installation by means of a wall-mount bracket. Concealed cable routing behind insulation. All connections G1" male thread, flat sealing. 2 multifunctional shut-off valves with thermometer (0-120 °C) and integrated temperature sensor connector, adjustable gravity brake in the flow. 3-way mixer (Kvs 6.3) with motor and temperature control. For operation in closed heating networks with non-aggressive media, such as water or water-glycol mixes as per VDI (Association of German Engineers) 2035/ÖNORM (Austrian standard) H 5195.

### **VB20**

Boiler manifold for pump groups FlowBox DN20 for the connection of 2 or 3 groups. 1" union nut connection to pump groups and 1" male thread connection to heating network. EPP insulation shell provides highly effective heat insulation. Simple installation. Thermal separation of supply and return. For operation in closed heating networks with non-aggressive media, such as water or water-glycol mixes as per VDI (Association of German Engineers) 2035/ÖNORM (Austrian standard) 5195. Suitable wall-mount bracket WH-VB20/25/32 available as accessory.

### **HW80/120 4m³/h**

Compact hydraulic separator ready for installation consisting of: Welded steel separator, filling and draining tap, immersion sleeve ½" - Di=6.5 mm, manual air vent, wall bracket, EPP heat insulation shell. 4 m³/h, 44 kW ( $\Delta t = 10$  K). All connections 1½" M. Insulated pipe connection set RB-HW80/120-VB20 for connection to manifold VB20 is available as accessories.

### **HW-Q60/80 1m³/h 1"**

Compact hydraulic separator ready for installation with ½" immersion sleeve, connection fittings, EPP heat insulation shell. 1.1 m³/h; 13.25 kW ( $\Delta t = 10$  K). Flat-sealing connection by means of union nut 1" transverse below pump groups FlowBox DN20 or manifold VB20. Connection to heat pipe network 1" M.

The descriptions and photographs contained in this product specification sheet are supplied by way of information only and are not binding. Watts Industries reserves the right to carry out any technical and design improvements to its products without prior notice.

Warranty: All sales and contracts for sale are expressly conditioned on the buyer's assent to Watts terms and conditions found on its website at [www.wattswater.eu/gtc/](http://www.wattswater.eu/gtc/). Watts hereby objects to any term, different from or additional to Watts terms, contained in any buyer communication in any form, unless agreed to in a writing signed by an officer of Watts.



**Watts Industries Deutschland GmbH**

Godramsteiner Hauptstr. 167 • 76829 Landau • Deutschland

Telefon: +49 6341 9656-0 • Fax: +49 6341 9656-560

E-Mail: [WIDE@wattswater.com](mailto:WIDE@wattswater.com) • [www.wattswater.de](http://www.wattswater.de)