

FlowBox DN25/32

Pump and pump mixer groups DN25 and DN32

VB25/32

Boiler manifolds DN25/DN32

Technical Data Sheet



Description

The pump groups FlowBox DN25/32 represent a complete ready-to-install assembly with thermal insulation, containing all necessary components (pump, shut-off and mixing valves, thermometers, check valves, pipes) for installation in a heating system. For models supplied without the pump unit, the pump is to be selected by the installer or heating engineer(s).

FlowBox HK25 and HK32



Compact pump group for direct heating circuits. 3-part patented EPP insulation shell provides a thermal insulation according to GEG (German Buildings Energy Act). Incl. wall bracket, fastening and 2 fittings for upper connection.

Supply: shut-off valve with gravity brake and integrated thermometer 0-120 °C, circulation pump 180 mm, additional shut-off valve under the pump (HK25-KH only).

Return: shut-off valve with integrated thermometer 0-120 °C.

Typ	Part no.	DN	Version	Weight
HK25	10084153	25	Wilo Para SC/6	5.73 kg
HK25	10084608	25	Grundfos UPM3A/7	6.30 kg
HK25	10087354	25	Lowara Eco2/8	-
HK25	10026450	25	without pump	4.20 kg
HK25-KH	10084609	25	Wilo Para SC/6, with additional shut-off valve	6.18 kg
HK25-KH	10084610	25	Grundfos UPM3A/7, with additional shut-off valve	6.75 kg
HK25-KH	10087355	25	Lowara Eco2/8, with additional shut-off valve	-
HK25-KH	10026635	25	without pump, with additional shut-off valve	4.65 kg
HK32	10084154	32	Wilo Para SC/6	6.55 kg
HK32	10084611	32	Grundfos UPM3A/7	7.25 kg
HK32	10087367	32	Lowara Eco2/8	-
HK32	10026881	32	without pump	5.15 kg

FlowBox HKM25 and HKM32



Compact pump and mixer group for mixed heating circuits. 3-part patented EPP insulation shell provides a thermal insulation according to GEG (German Buildings Energy Act). Incl. wall bracket, fastening and 2 fittings for upper connection.

Supply: shut-off valve with gravity brake and integrated thermometer 0-120 °C, circulation pump (180 mm), 3-way mixer and motor.

Return: shut-off valve with integrated thermometer 0-120 °C.

The flow and return pipes of FlowBox HKM25/32 are interchangeable from left to the right side.

Typ	Part no.	DN	Kvs	Version	Weight
HKM25	10084152	25	6.3	Wilo Para SC/6	6.93 kg
HKM25	10084612	25	6.3	Grundfos UPM3A/7	7.60 kg
HKM25	10087356	25	6,3	Lowara Eco2/8	-
HKM25	10026451	25	6.3	without pump	5.50 kg
HKM32	10084155	32	18	Wilo Para SC/6	8.18 kg
HKM32	10084613	32	18	Grundfos UPM3A/7	8.75 kg
HKM32	10087368	32	18	Lowara Eco2/8	-
HKM32	10026883	32	18	without pump	6.70 kg

FlowBox HKF25



Compact pump and mixer group for mixed heating circuits with thermostatic fixed temperature control. Setting range: 20-55 °C or 30-70 °C. 3-part patented EPP insulation shell provides a thermal insulation according to GEG (German Buildings Energy Act). Incl. wall bracket, fastening and 2 fittings for upper connection.

Supply: shut-off valve with gravity brake and integrated thermometer 0-120 °C, circulation pump 180 mm, 3-way thermostatic mixing valve.

Return: shut-off valve with integrated thermometer 0-120 °C.

The flow and return pipes of FlowBox HKF25 are interchangeable from left to the right side.

Typ	Part no.	DN	Setting range	Version	Weight
HKF25	10084597	25	20 - 55 °C	Wilo Para SC/6	5.80 kg
HKF25	10084598	25	20 - 55 °C	Grundfos UPM3A/7	7.24 kg
HKF25	10087359	25	20 - 55 °C	Lowara Eco2/8	-
HKF25	10084599	25	20 - 55 °C	without pump	5.50 kg
HKF25	10084600	25	30 - 70 °C	Wilo Para SC/6	5.80 kg
HKF25	10084601	25	30 - 70 °C	Grundfos UPM3A/7	7.24 kg
HKF25	10087360	25	30 - 70 °C	Lowara Eco2/8	-
HKF25	10084602	25	30 - 70 °C	without pump	5.50 kg

FlowBox HKFC25



Compact pump and mixer group for mixed heating circuits with electrical fixed temperature control. Setting range: 5-95 °C¹⁾. 3-part patented EPP insulation shell provides a thermal insulation according to GEG (German Buildings Energy Act). Incl. wall bracket, fastening and 2 fittings for upper connection.

Supply: shut-off valve with gravity brake and integrated thermometer 0-120 °C, circulation pump 180 mm, 3-way mixing valve, motor incl controller.

Return: shut-off valve with integrated thermometer 0-120 °C.

The flow and return pipes of FlowBox HKFC25 are interchangeable from left to the right side.

Typ	Part no.	DN	Setting range	Version	Weight
HKFC25	10084603	25	5 - 95 °C	Wilo Para SC/6	6.73 kg
HKFC25	10084604	25	5 - 95 °C	Grundfos UPM3A/7	7.24 kg
HKFC25	10087361	25	5 - 95 °C ¹⁾	Lowara Eco2/8	-
HKFC25	10084605	25	5 - 95 °C	without pump	5.50 kg

1) Note the maximum operating temperature of the circulation pump!

VB25/32



Boiler manifold for the connection of 2 to 5 pump groups FlowBox DN25/32.

Connection to pump groups: 1½" UN; connection to the installation: 1½" M. Thermal insulation by EPP insulation shell with thermal separation of supply and return chamber. Suitable wall-mount bracket WH-VB20/25/32 available as accessory.

Typ	Part no.	Version	Weight
VB25/32-2	10025900	for connection of 2 pump groups	5.90 kg
VB25/32-3	10025901	for connection of 3 pump groups	8.80 kg
VB25/32-4	10026672	for connection of 4 pump groups	13.20 kg
VB25/32-5	10026931	for connection of 5 pump groups	16.50 kg
WH-VB20/25/32	10026388	wall brackets for VB20 and VB25/32	0.35 kg

Technical Data

Hydraulic performance data		Pump groups FlowBox DN25/32				
Max. operating pressure	6 bar					
Ambient temperature	-10 °C to +40 °C (note pump specification!)					
Operating temperature	+2 °C to +90 °C (note pump specification!)					
	HK25	HK32	HKM25	HKM32	HKF25	HKFC25
Recommended range of application (at $\Delta T=20$ K, $\Delta p=100$ mbar)	max. 46 kW	bis 86 kW	max. 32 kW	max. 81 kW	max. 25 kW	max. 32 kW
Nominal size	DN25	DN32	DN25	DN32	DN25	DN25
Kvs-value	-	-	6.3	18.0	4.5	6.3
Opening pressure of gravity brake	10 mbar					
Thermometer display range	0 - 120 °C					
Media	Water or water-glycol mixes as per VDI (Association of German Engineers) 2035 / ÖNORM (Austrian standard) H 5195					
Power supply connection		See separate pump and actuator documentation				
Dimensions						
W × H × D with insulation shell	300 × 370 × 240 mm					
Axial distance	125 mm					
Weight	packing excluded	packing included				
	see description tables	approx. 0.5 kg more than net weight				
Pumping connections	DN25 (HK25/HKM25/HKF25/HKFC25)	DN32 (HK32/HKM32)				
heating circuits (top)	1½"M, fitting 1½"UN × 1"F	2"M, fitting 2"UN × 1¼"F				
boiler (bottom)	1½"M flat sealing for all FlowBox pump groups DN25/32					
Materials						
Pipes	coated tubular steel					
Valves / fittings / connecting pipe	brass CW617N					
Gaskets	AFM34					
Insulation shell	EPP					
Gravity brake	POM, NBR, stainless steel					
Plastics	Impact- and temperature-resistant					
O-rings	EPDM					
Wall brackets	Steel plate, zinc-plated					
Tightening torques for screw connections		¾": 35 Nm; 1": 55 Nm; 1 ¼": 90 Nm; 1 ½": 130 Nm; 2": 190 Nm				
Circulation pumps and motors	See product-specific documentation for technical data of circulating pumps.					

Hydraulic performance data		Manifold VB25/32			
Max. operating pressure	6 bar				
Operating temperature	2 °C to 110 °C				
Flow rate	max. 3 m³/h				
Power	max. 70 kW (at V=1m/s and $\Delta T=20$ K)				
Media	Water or water-glycol mixes as per VDI (Association of German Engineers) 2035 / ÖNORM (Austrian standard) H 5195				
Nominal size	DN32				
Kvs-value	VB25/32-2: 20	VB25/32-3: 21	VB25/32-4: 24	VB25/32-5: 24	
Dimensions (W × H × D with insulation)	see section "Dimensions"				
Weight	packing excluded	packing included			
	see description tables	approx. 0.5 kg more than net weight			
Connections					
to heating circuit	1½" union nut with flat sealing				
to boiler	1½" male thread with flat sealing				
Materials					
Manifold	Steel pipe				
Union nut / sealing cap	brass CW617N				
Flat gaskets	EPDM				
Insulation shell	EPP				

Charts

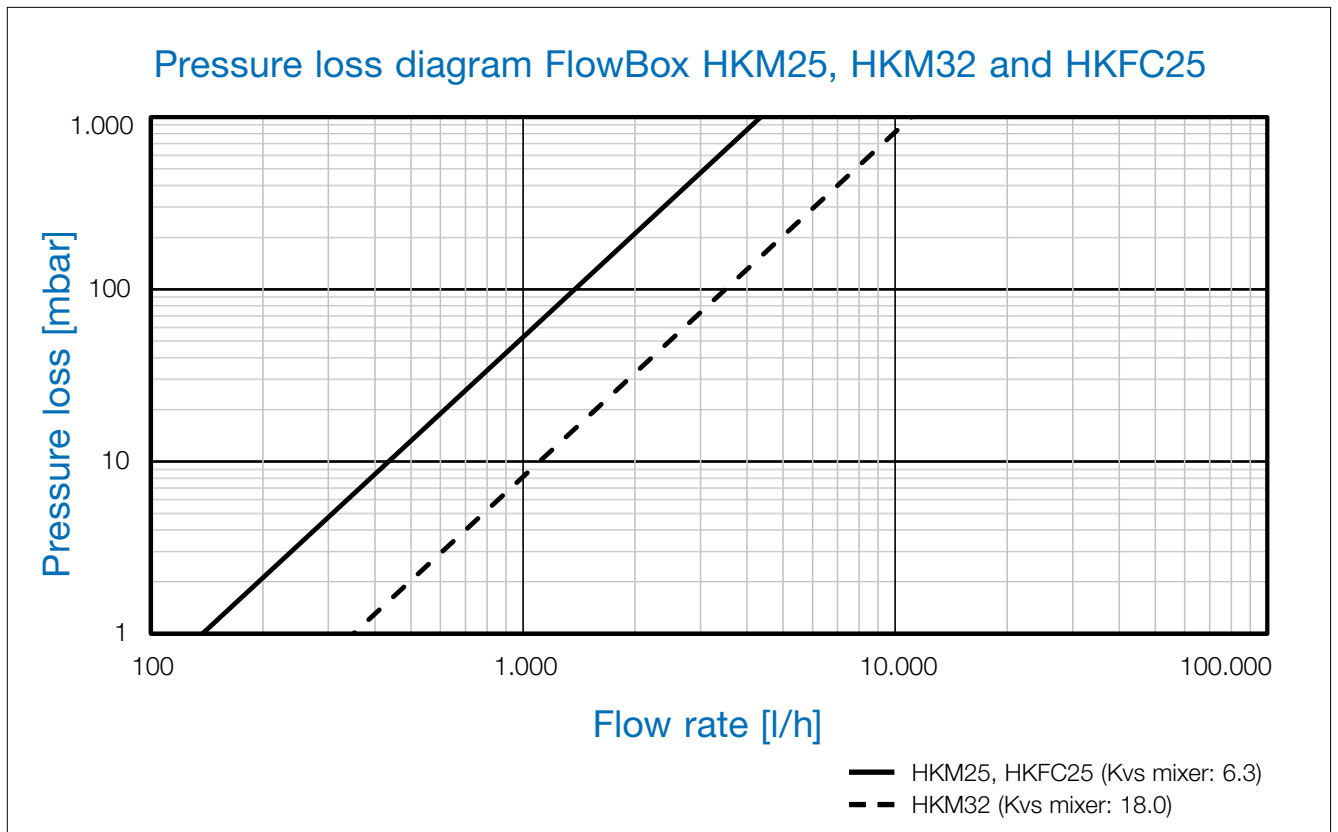
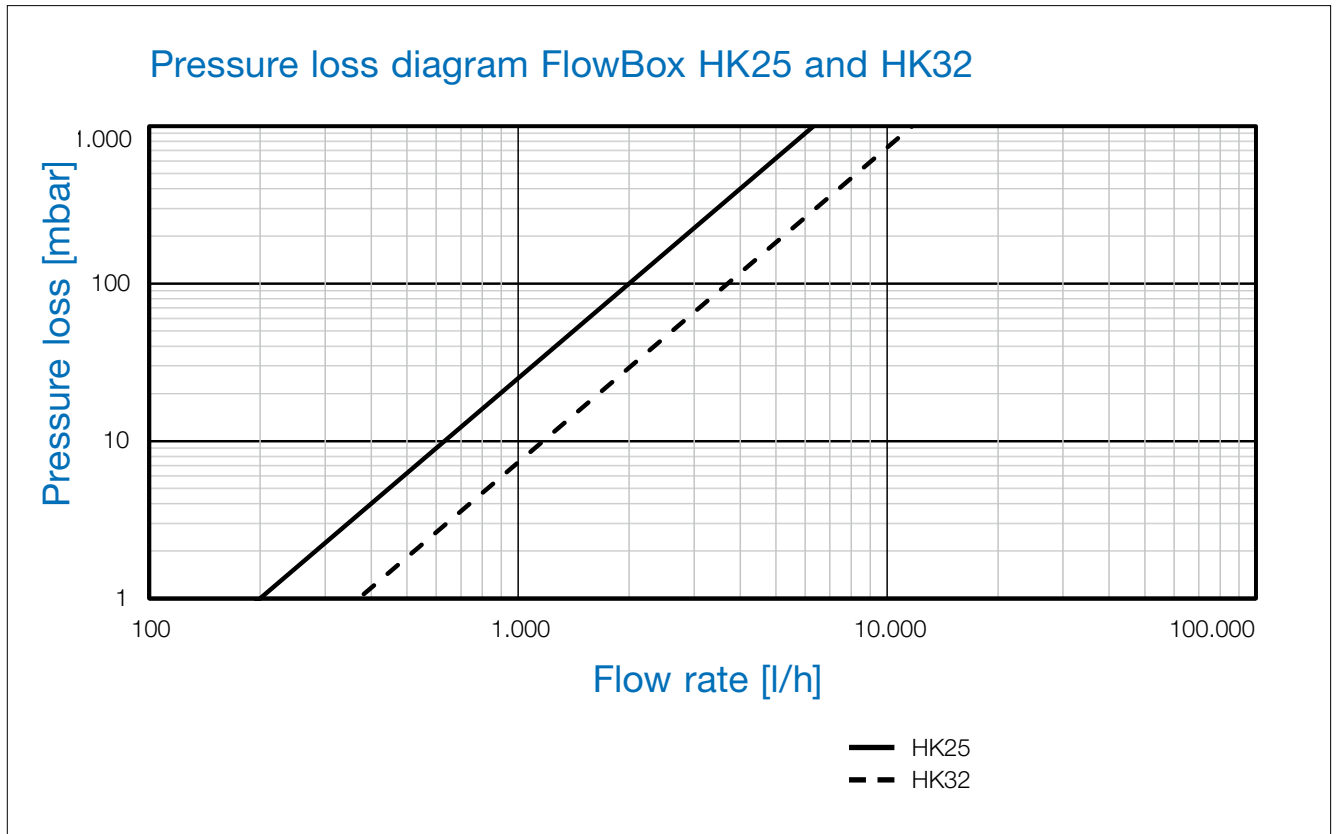

Pressure loss diagram FlowBox HKF25

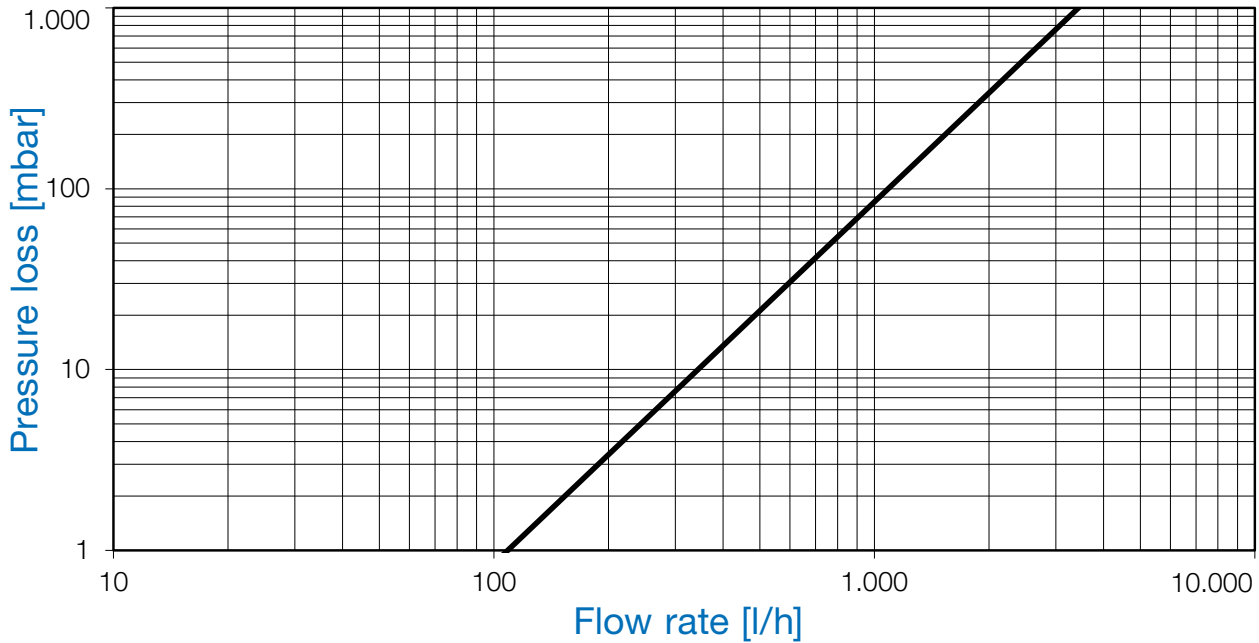

Pressure loss diagram manifold VB25/32

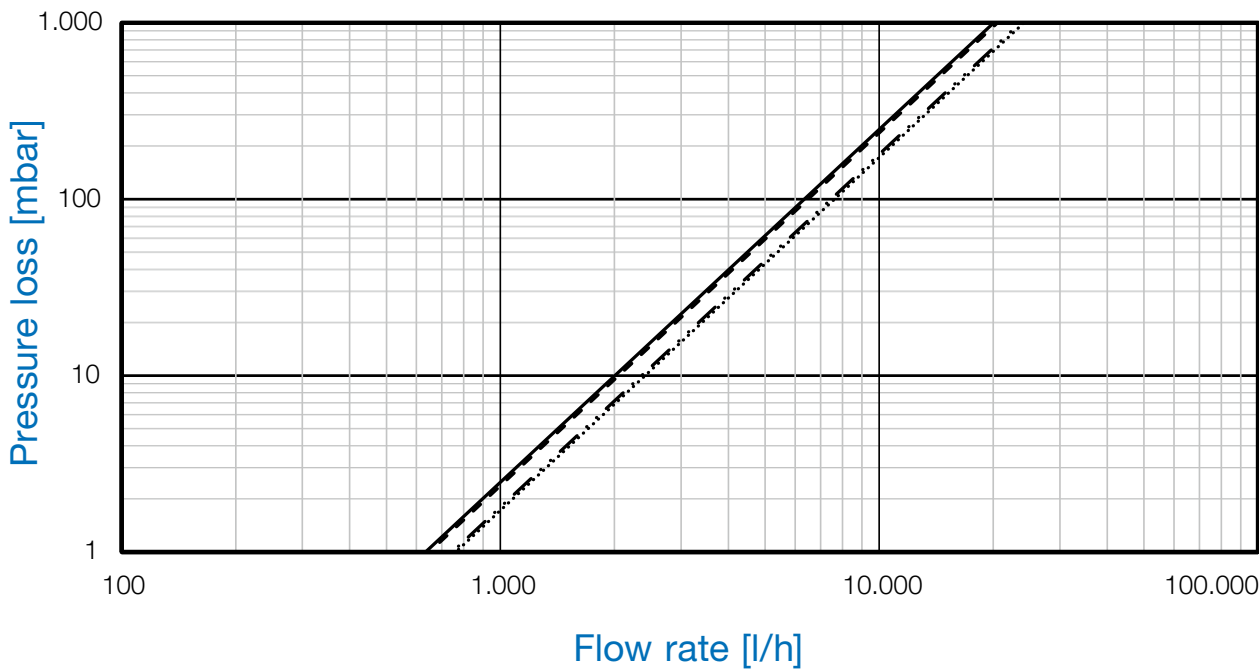

- VB25/32-2
- - - VB25/32-3
- VB25/32-4
- · - VB25/32-5

Application

The pump groups Watts FlowBox DN25/32 are used to connect boilers to mixed (HKM/HKF/HKFC) or direct heating circuits (HK) in the heating systems. The distribution manifold VB25/32 allows the installation of 2 up to 5 pump groups side by side.

Construction

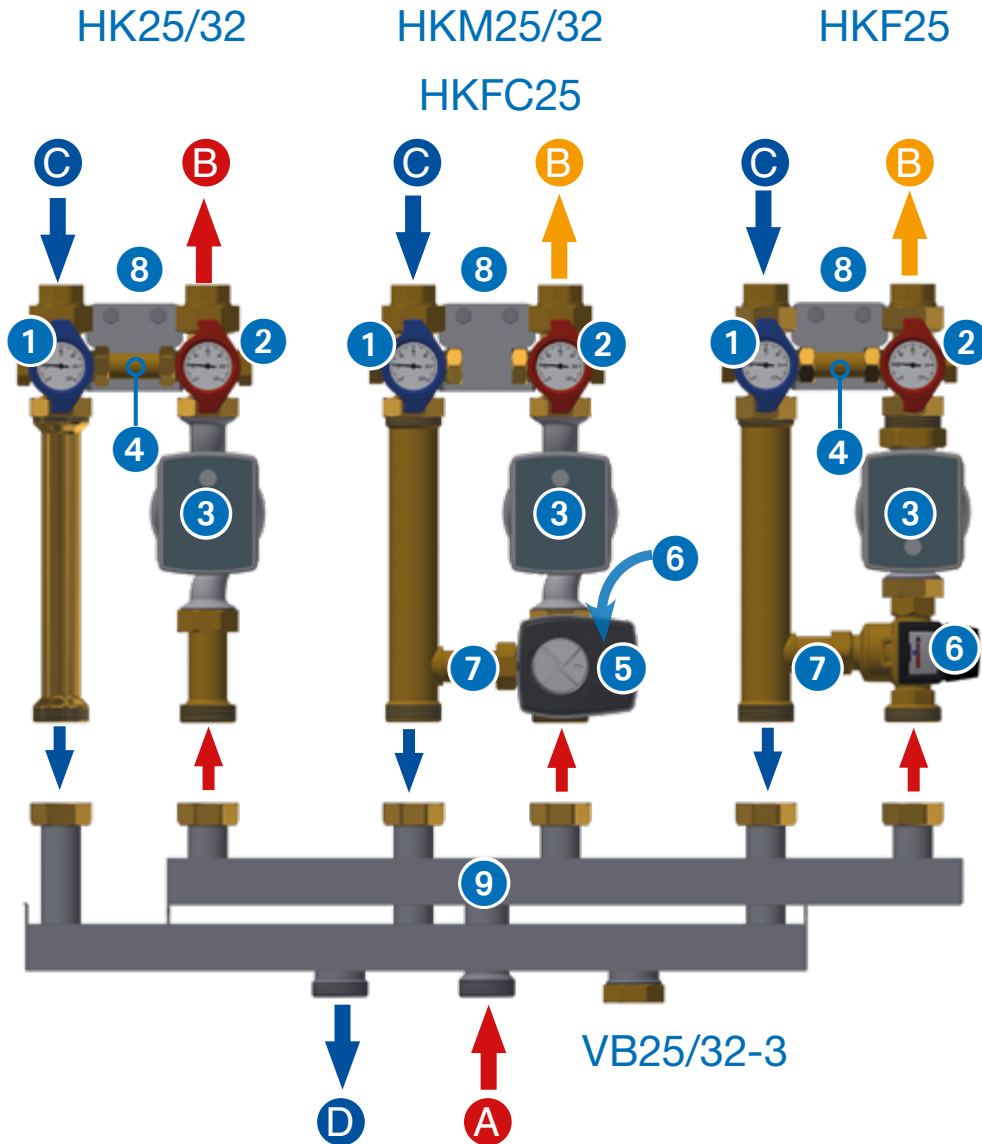

- | | | | |
|---|--|---|---------------------------------|
| 1 | Shut off valve (return line) | A | Supply inlet (heating circuit) |
| 2 | Shut off valve with gravity brake (supply) | B | Supply outlet (heating circuit) |
| 3 | Circulation pump | C | Return inlet (heating circuit) |
| 4 | Stabilization pipe | D | Return outlet (boiler circuit) |
| 5 | Motor (HKM25 or HKM32) | | |
| | Motor with controller (HKFC25) | | |
| 6 | 3-way-mixer (HKM25/32, HKFC25) | | |
| | Thermostatic mixing valve (HKF25) | | |
| 7 | Bypass | | |
| 8 | Wall brackets | | |
| 9 | Boiler manifold | | |

Installation variants

For maximum flexibility, when connecting additional components to the boiler manifold, two connecting ports for the return line are available to the fitter. The Flowbox and boiler manifold arrangement may be even be entirely reversed if necessary.

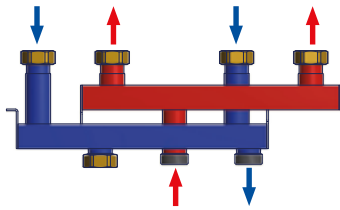

The left return port is closed

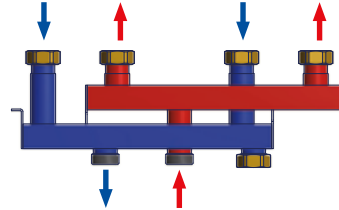

The right return port is closed

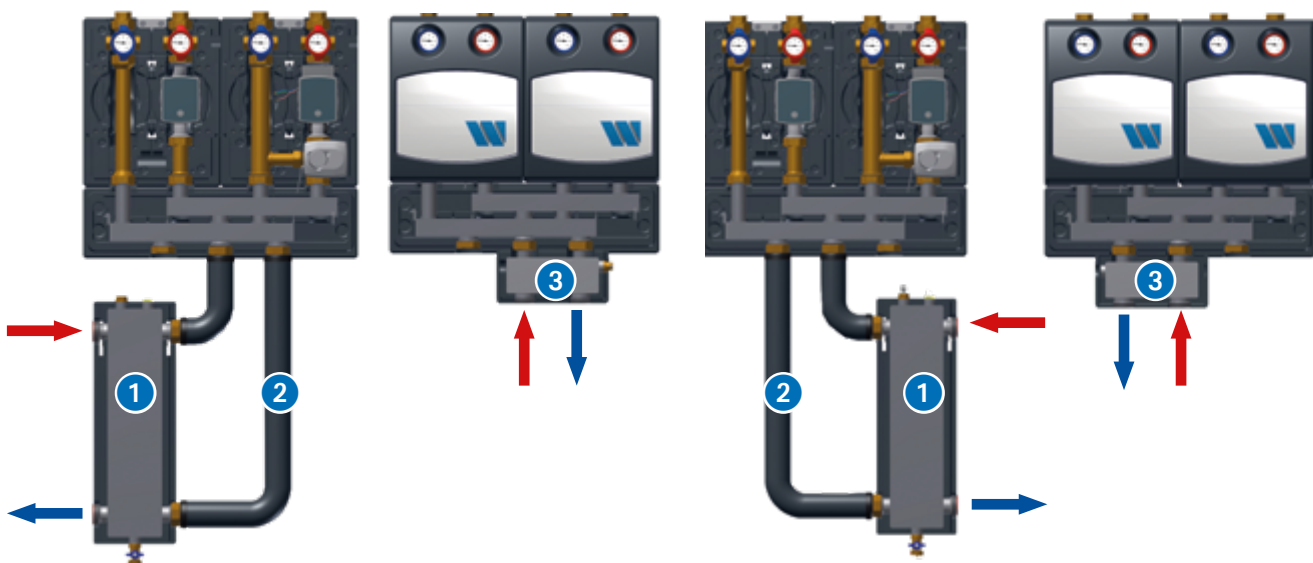

Hydraulic separators

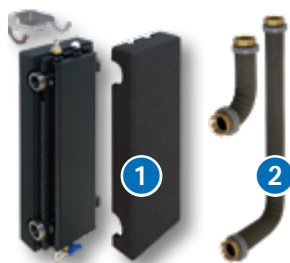

HW80/120 and RB-HW80/120-VB25/32

Compact hydraulic separator with EPP insulation, fill and drain-cock, immersion sleeve 1/2", Di=6.5 mm for thermometer, manual air-vent, screw connections, wall bracket.

RB-HW: connection set consisting of two heat insulated pipes for direct connection of the HW80/120 to pump groups FlowBox DN25/32 or to distribution manifold VB25/32.

Typ	Part no.	Version	Weight
HW 80/120	10010376	4 m³/h, 44 kW ($\Delta t = 10$ K)	6.45 kg
RB-HW 80/120-VB25/32	10010378	insulated pipe connection set	2.4 kg



HW-Q60/80

Compact hydraulic separator with EPP insulation for direct connection to pump groups FlowBox DN25/32 or to distribution manifold VB25/32.

Typ	Part no.	Version	Weight
HW-Q60/80 1 1/2"	10010424	1.5 m³/h 18 kW ($\Delta t = 10$ K)	2.66 kg

Insulation

The thermal insulation of the pump groups FlowBox DN25/32 and distribution manifold VB25/32 are of uniform design. The patented, three-part insulation shells ensure GEG (German Buildings Energy Act) thermal insulation.

Rear insulating shell:

Pre-stamped cable ducts for clean and discreet cable routing in all directions; sound protection.



Middle insulating shell:

Thermal insulation of the sensitive pump electronics parts from the hydraulic parts of the pump group.



Front insulation shell:

Heat and dust protection; Ventilation of pump electronics parts through slots in the top and bottom of the bowl.



Manifold insulation shell:

Supply and return chambers are thermally separated from each other by an insulating shell.



Installation with interchanged flow and return

The pump groups are supplied with flow on the right side. The return and flow of the mixer groups HKM25/32, HKF25 and HKFC25 can be interchanged in a few steps (see operating instructions). For mounting on boiler manifold, the latter must be turned 180° (as shown below).

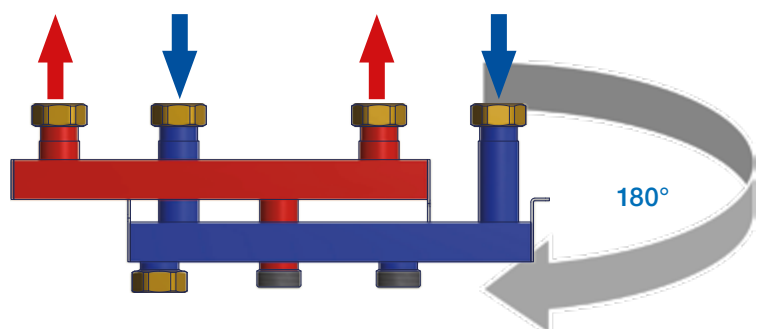
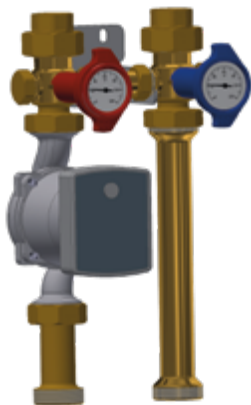

Dimensions [mm]

Pump groups FlowBox DN25/32 and manifolds VB25/32

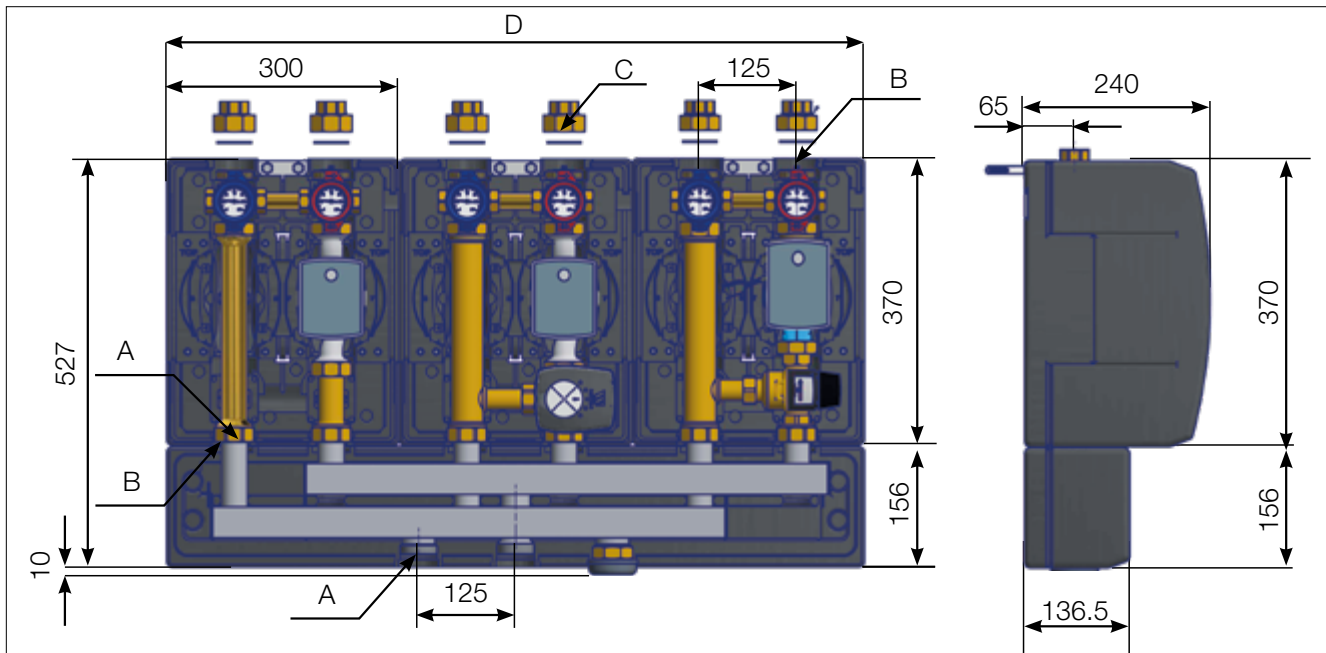

Typ	DN	A	B	C	D
HK25, HKM25	DN25	1½" M	1½" M	1½" UN x 1" F	
HKF25, HKFC25	DN25	1½" M	1½" M	1½" UN x 1" F	
HK32, HKM32	DN32	1½" M	2" M	2" UN x 1¼" F	
VB25/32-2	DN32	1½" M	1½" M		600 mm
VB25/32-3	DN32	1½" M	1½" UN		900 mm
VB25/32-4	DN32	1½" M	1½" UN		1200 mm
VB25/32-5	DN32	1½" M	1½" UN		1500 mm

M = male thread F = female thread UN = union nut

HW80/120 and RB-HW80/120-VB25/32

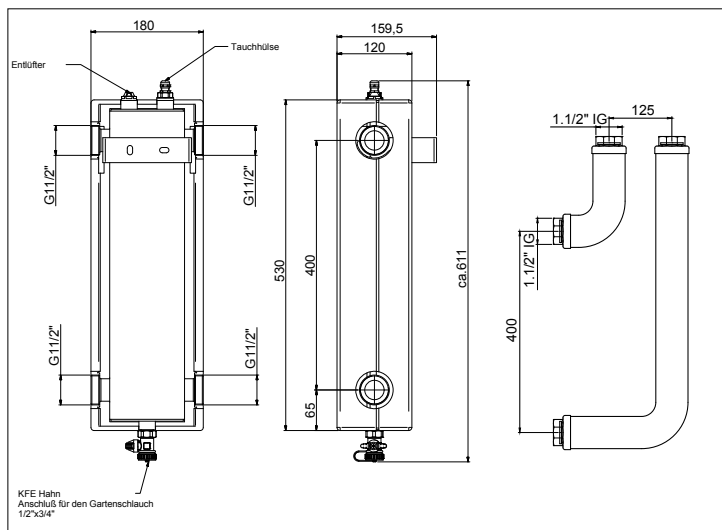

HW-Q60/80

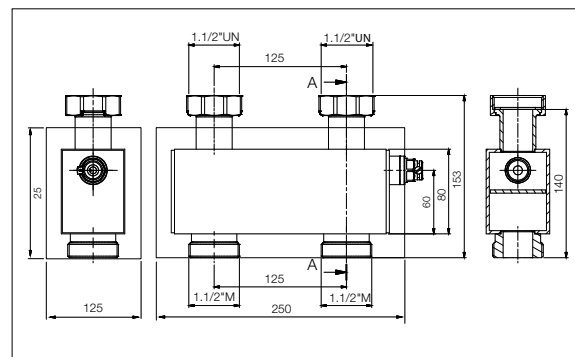

Product texts

FlowBox HK25

Pump group for connecting boilers to unmixed heating circuits. Space-saving design with a pump length of 180 mm and an axial distance of 125 mm. A patented EPP insulation shell provides a highly effective heat insulation conforming to GEG (German Buildings Energy Act). Simple installation by means of a wall-mount bracket. Concealed cable routing behind insulation. Connection at the top: 2 fittings with 1½" union nut x 1" F. Connection at the bottom: G1½" M with flat sealing. 2 multifunctional shut-off valves with thermometer (0-120 °C), adjustable gravity brake in the flow. For operation in closed heating networks with non-aggressive media, such as water or water-glycol mixes as per VDI (Association of German Engineers) 2035/ÖNORM (Austrian standard) H 5195.

FlowBox HK32

Pump group for connecting boilers to unmixed heating circuits. Space-saving design with a pump length of 180 mm and an axial distance of 125 mm. A patented EPP insulation shell provides a highly effective heat insulation conforming to GEG (German Buildings Energy Act). Simple installation by means of a wall-mount bracket. Concealed cable routing behind insulation. Connection at the top: 2 fittings with 2" union nut x 1¼" F. Connection at the bottom: G1½" M with flat sealing. 2 multifunctional shut-off valves with thermometer (0-120 °C), adjustable gravity brake in the flow. For operation in closed heating networks with non-aggressive media, such as water or water-glycol mixes as per VDI (Association of German Engineers) 2035/ÖNORM (Austrian standard) H 5195.

FlowBox HKM25

Pump and mixer groups for connecting boilers to mixed heating circuits. Space-saving design, pump length of 180 mm and an axial distance of 125 mm. Simple conversion from right to left, the actuator can be mounted in several directions. A patented EPP insulation shell provides a highly effective heat insulation conforming to GEG (German Buildings Energy Act). Simple installation by means of a wall-mount bracket. Concealed cable routing behind insulation. Connection at the top: 2 fittings with 1½" union nut x 1" F. Connection at the bottom: G1½" M with flat sealing. 2 multifunctional shut-off valves with thermometer (0-120 °C), adjustable gravity brake in the flow. 3-way mixer (Kvs 6.3) with motor. For operation in closed heating networks with non-aggressive media, such as water or water-glycol mixes as per VDI (Association of German Engineers) 2035/ÖNORM (Austrian standard) H 5195.

FlowBox HKM32

Pump and mixer groups for connecting boilers to mixed heating circuits. Space-saving design, pump length of 180 mm and an axial distance of 125 mm. Simple conversion from right to left, the actuator can be mounted in several directions. A patented EPP insulation shell provides a highly effective heat insulation conforming to GEG (German Buildings Energy Act). Simple installation by means of a wall-mount bracket. Concealed cable routing behind insulation. Connection at the top: 2 fittings with 2" union nut x 1¼" F. Connection at the bottom: G1½" M with flat sealing. 2 multifunctional shut-off valves with thermometer (0-120 °C), adjustable gravity brake in the flow. 3-way mixer (Kvs 18.0) with motor. For operation in closed heating networks with non-aggressive media, such as water or water-glycol mixes as per VDI (Association of German Engineers) 2035/ÖNORM (Austrian standard) H 5195.

FlowBox HKF25

Pump and mixer groups with thermostatic fix point control for connecting boilers to mixed heating circuits. Space-saving design with a pump length of 180 mm and an axial distance of 125 mm. Simple conversion from right to left. A patented EPP insulation shell provides a highly effective heat insulation conforming to GEG (German Buildings Energy Act). Simple installation by means of a wall-mount bracket. Concealed cable routing behind insulation. Connection at the top: 2 fittings with 1½" union nut x 1" F. Connection at the bottom: G1½" M with flat sealing. 2 multifunctional shut-off valves with thermometer (0-120 °C), adjustable gravity brake in the flow. Thermostatic 3-way mixer with setting range: 20-55 °C or 30-70 °C. For operation in closed heating networks with non-aggressive media, such as water or water-glycol mixes as per VDI (Association of German Engineers) 2035/ÖNORM (Austrian standard) H 5195.

FlowBox HKFC25

Pump and mixer groups with electrical fix point control for heating systems for connecting boilers to mixed heating circuits. Space-saving design, pump length of 180 mm and an axial distance of 125 mm. Simple conversion from right to left, the actuator can be mounted in several directions. A patented EPP insulation shell provides a highly effective heat insulation conforming to GEG (German Buildings Energy Act). Simple installation by means of a wall-mount bracket. Concealed cable routing behind insulation. Connection at the top: 2 fittings with 1½" union nut x 1" F. Connection at the bottom: G1½" M with flat sealing. 2 multifunctional shut-off valves with thermometer (0-120 °C), adjustable gravity brake in the flow. 3-way mixer, motor with temperature control with setting range 5-95 °C. For operation in closed heating networks with non-aggressive media, such as water or water-glycol mixes as per VDI (Association of German Engineers) 2035/ÖNORM (Austrian standard) H 5195.

VB25/32

Boiler manifold for pump groups FlowBox DN25/32 for the connection of up to 5 groups. 1½" union nut connection to pump groups and 1½" male thread connection to heating network. EPP insulation shell provides highly effective heat insulation. Simple installation. Thermal separation of supply and return. For operation in closed heating networks with non-aggressive media, such as water or water-glycol mixes as per VDI (Association of German Engineers) 2035/ÖNORM (Austrian standard) 5195. Suitable wall-mount bracket WH-VB20/25/32 available as accessory.

HW80/120 4m³/h

Compact hydraulic separator ready for installation consisting of: Welded steel separator, filling and draining tap, immersion sleeve ½" - Di=6.5 mm, manual air vent, wall bracket, EPP heat insulation shell. 4 m³/h, 44 kW (Δt = 10 K). All connections 1½" M. Insulated pipe connection set RB-HW80/120-VB32 for connection to manifold VB25/32 is available as accessories.

HW-Q60/80 1.5m³/h 1½"

Compact hydraulic separator ready for installation with ½" immersion sleeve, connection fittings, EPP heat insulation shell. 1.5 m³/h, 18 kW (Δt = 10 K). Flat-sealing connection by means of union nut 1½" transverse below pump groups FlowBox DN25/32 or manifold VB25/32. Connection to heat pipe network 1½" M.

Further pump groups



FlowBox DN 20

for the connection of heating boilers to mixed and unmixed heating circuits, available in the dimension DN20



FlowBox DN 40/50

for the connection of heating boilers to mixed and unmixed heating circuits, available in the dimensions DN40 and DN50

Online Information

Current information on WATTS pump groups can be found on our homepage:

Service-Link: www.wattswater.eu/flowbox-eu/



The descriptions and photographs contained in this product specification sheet are supplied by way of information only and are not binding. Watts Industries reserves the right to carry out any technical and design improvements to its products without prior notice.

Warranty: All sales and contracts for sale are expressly conditioned on the buyer's assent to Watts terms and conditions found on its website at www.wattswater.eu/gtc/. Watts hereby objects to any term, different from or additional to Watts terms, contained in any buyer communication in any form, unless agreed to in a writing signed by an officer of Watts.

WWATTS®

Watts Industries Deutschland GmbH

Godramsteiner Hauptstr. 167 • 76829 Landau • Deutschland

Telefon: +49 6341 9656-0 • Fax: +49 6341 9656-560

E-Mail: WIDE@wattswater.com • www.wattswater.de