

Vision[®] System

Description and application guide



WATTS[®]



VISION® SYSTEM

- Comfort and energy saving
- Simple to add additional Vision® products to upgrade system with an extending range of products

-> In addition For Wireless

- Full control from anywhere with the WATTS app.
- Energy Metering for electrical devices
- Ideal for renovation, no need to pull wire
- Centrally controlled by WATTS app.



Vision® System general overview

Available in two versions, the Vision® is designed to maximize your comfort and save energy.

Vision® Wired enables you to control hydronic underfloor heating and cooling, and the temperature of individual rooms.

Vision® Wireless is a Smart Home System to control both hydronic and electric underfloor, radiator heating, lighting and other electrical appliances. Thanks to the central touch screen, you get access to your home's setting anywhere with the WATTS app.

It's made up of different families of products:

- Thermostat
- Multi-zone connecting box for hydronic floor heating and cooling

+ for **Wireless**

- Smart radiator thermostat
- Smart Plug
- Central Unit



INDIVIDUAL RESIDENTIAL



COLLECTIVE RESIDENTIAL

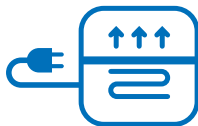

ELECTRICAL HEATING



HYDRONIC HEATING



NEW CONSTRUCTION



RENOVATION

Vision[®] System

Table of contents

Vision [®] System general overview	2
Application guide and configuration system	4

Vision[®] Wireless

Application 1: Hydronic heating and cooling multizone	6
Application 2: Hydronic heating and cooling monozone	8
Application 3: Electric heating multizone RF	10

Vision[®] Wired

Application 4: Hydronic heating multizone	12
Application 5: Hydronic heating and cooling monozone	14

ICONS



MONO
ZONE



MULTI
ZONE



WIRELESS



WIRED

Application guide and configuration system for Vision® Wireless

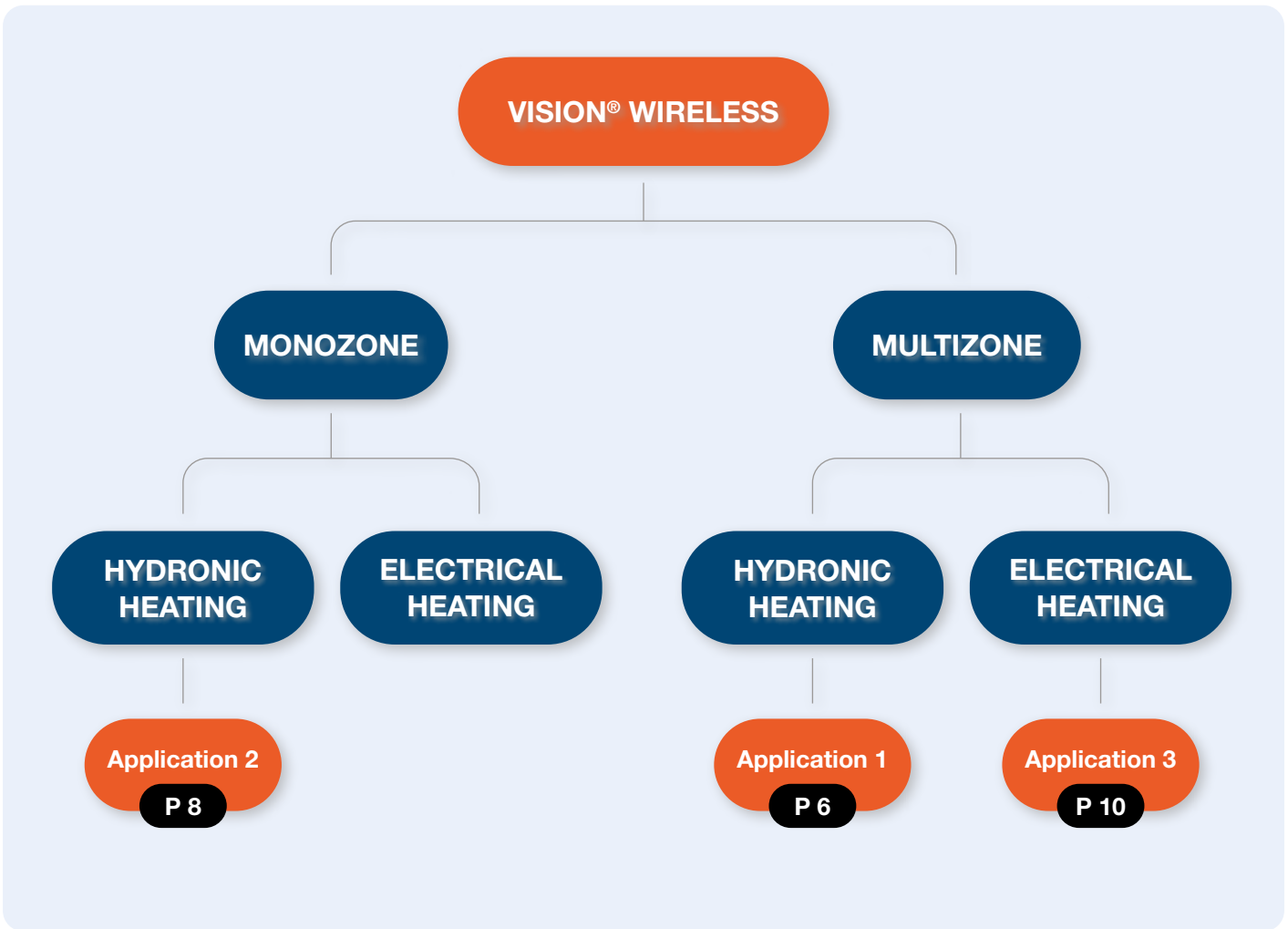

System overview

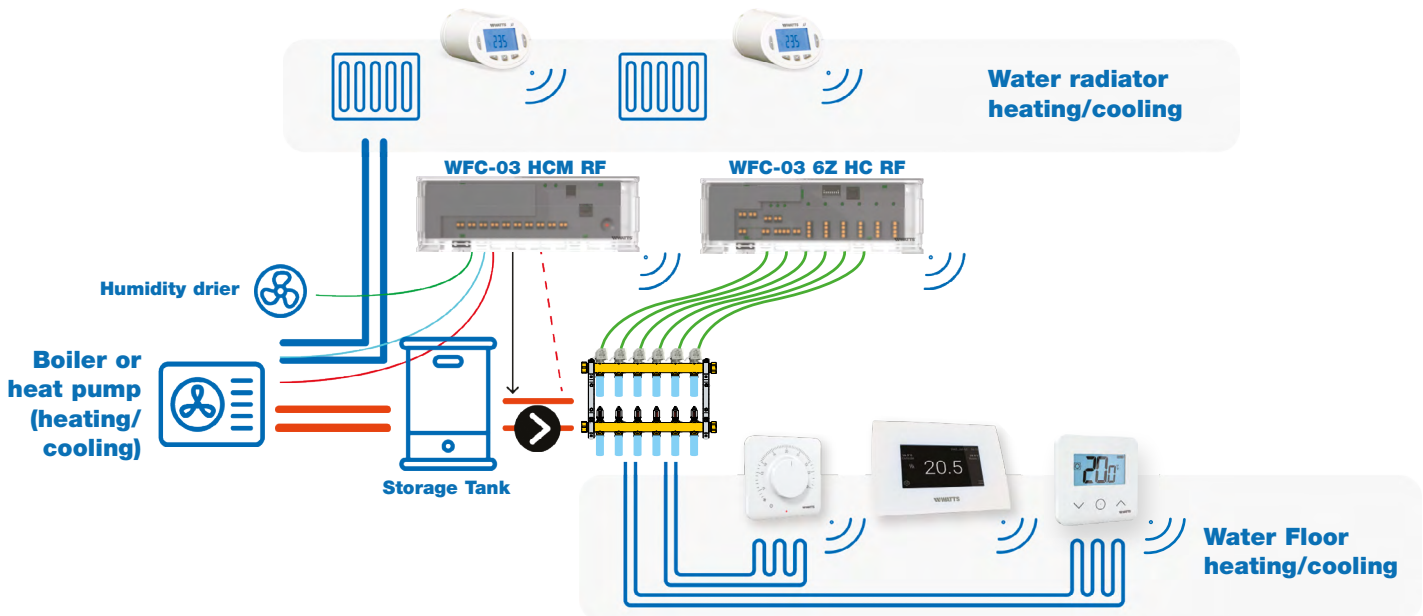

Application guide and configuration system for Vision® Wired

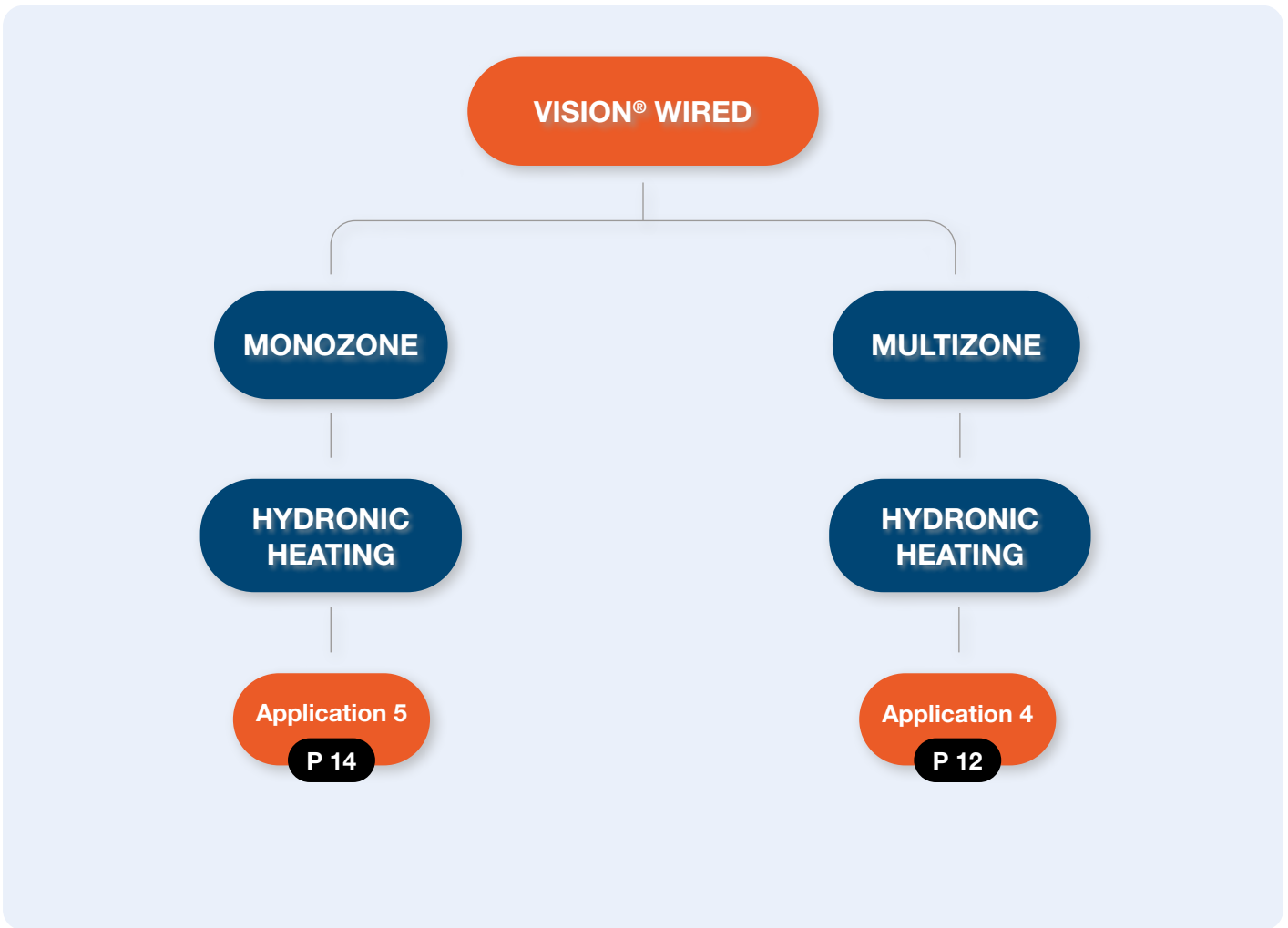

System overview

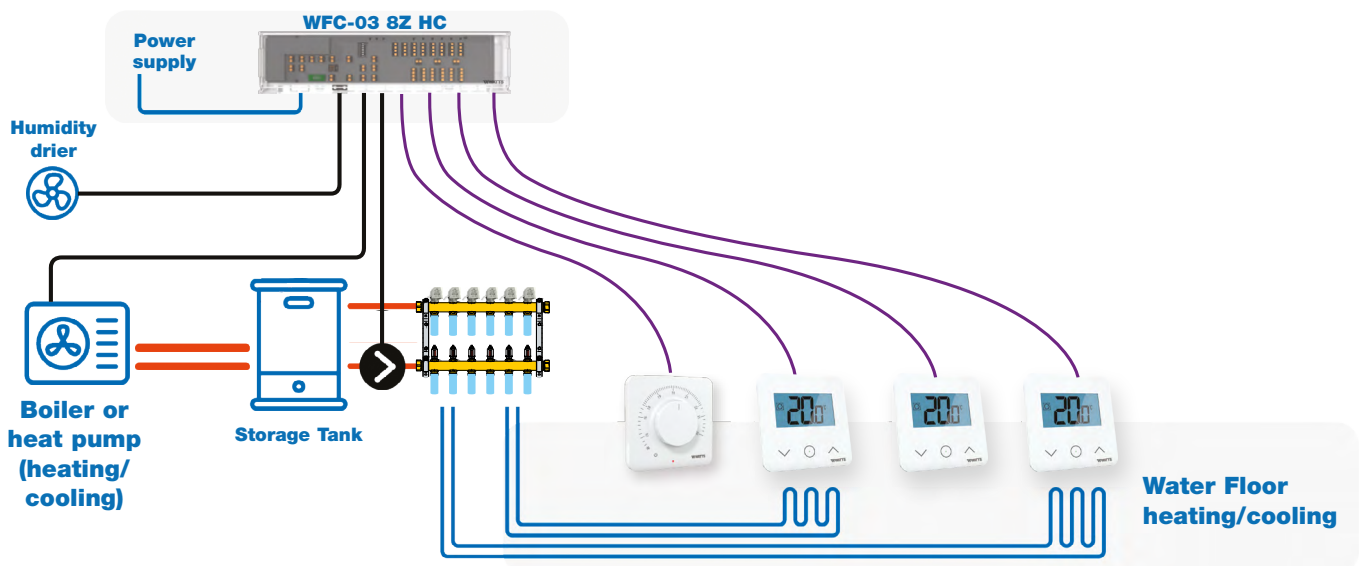



Vision® Wireless

Application 1: Hydronic heating and cooling multizone

EQUIPMENT

- 1 Central Unit CT03 RF
- 4 (or more) Thermostats D03 RF or A03 RF
- Several electronic thermostatic heads TH-02 RF
- 1 Connecting box WFC-03 6Z HC RF
- 1 Connecting box WFC-03 HCM RF to drive the heating or cooling mode
- Several actuators 22CX

INSTALLATION



MONO
ZONE



MULTI
ZONE



WIRELESS



WIRED



PRODUCTS

1 central unit
CT03 RF



4 (or more) thermostats
D03 RF or A03 RF



HEATING SYSTEM 1



BOILER



HEAT PUMP



HYDRONIC FLOOR HEATING



WATER RADIATOR

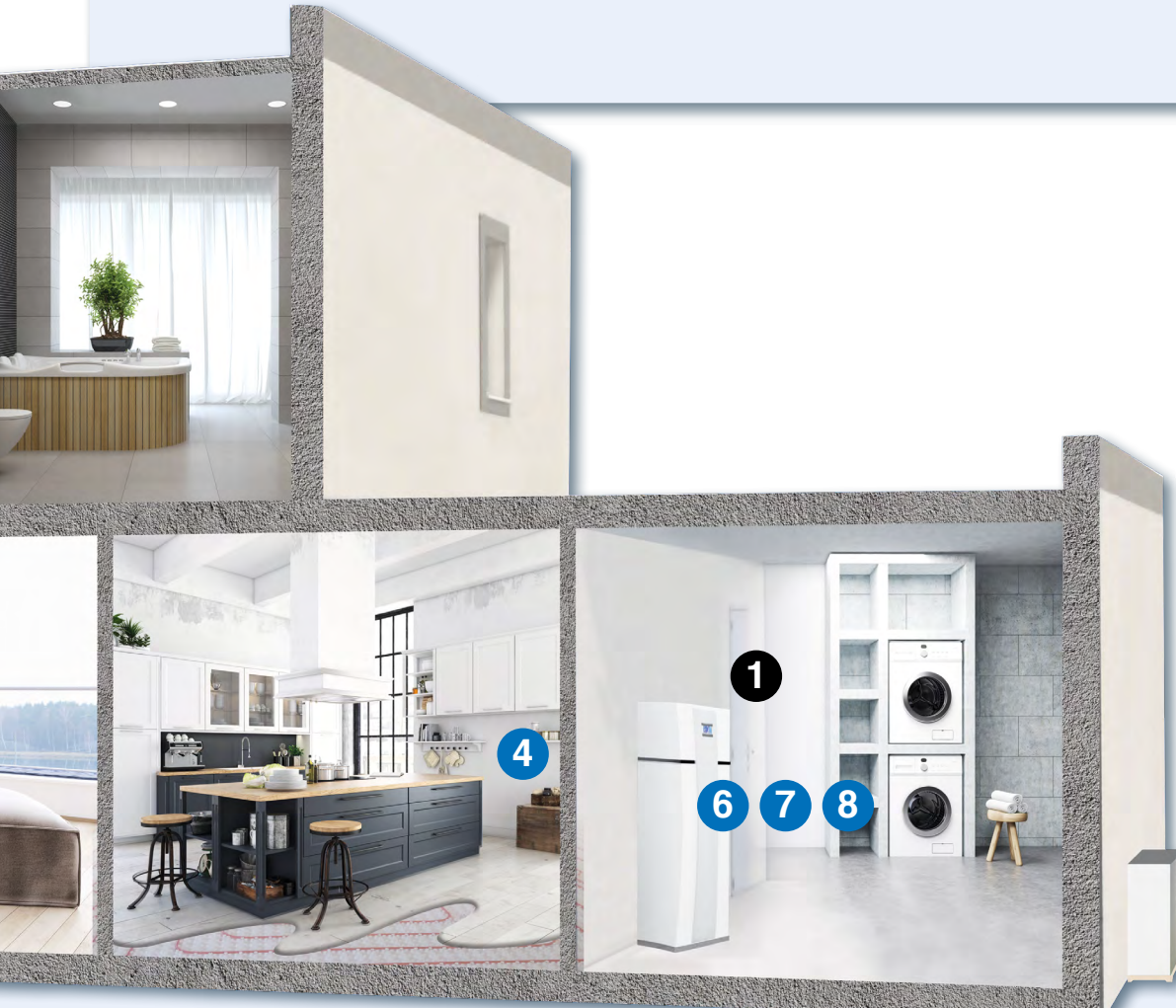

Electronic thermostatic heads
TH-02 RF

5



6 zones connecting box
WFC-03 6Z HC RF

6



Actuators
22CX

7



Heat pump driving for water floor heating and cooling
WFC-03 HCM RF

8





Vision® Wireless

Application 2: Hydronic heating and cooling monozone

EQUIPMENT

- 1 Central Unit CT03 RF
- 1 Thermostat D03 RF or A03 RF
- 1 Receiver WR02 FC RF

INSTALLATION



MONO
ZONE



MULTI
ZONE



WIRELESS



WIRED

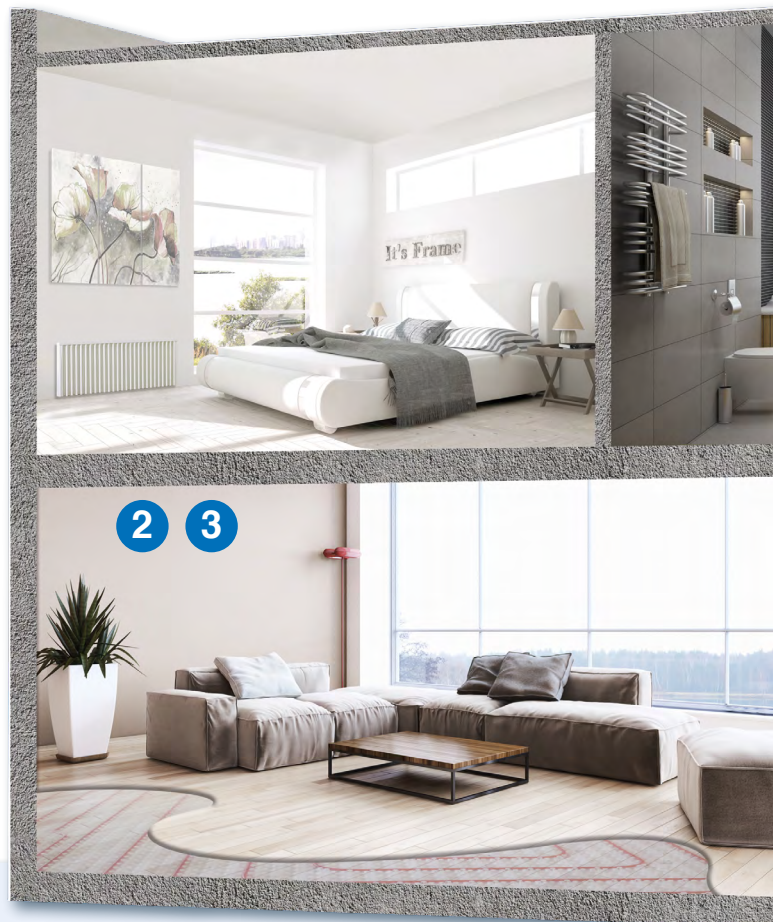

PRODUCTS

1 central unit
CT03 RF

2



1 digital thermostat
D03 RF

3



HEATING SYSTEM 1



BOILER



HEAT PUMP



HYDRONIC FLOOR HEATING



1 receiver
WR02 FC RF

4





Vision® Wireless

Application 3: Electric heating multizone RF

EQUIPMENT

- 1 Central Unit CT03 RF
- 5 or more Thermostats D03 RF or A03 RF
- Several receivers : FR02 RF or WR02 RF

INSTALLATION



MONO
ZONE



MULTI
ZONE



WIRELESS



WIRED



PRODUCTS

1 central unit
CT03 RF

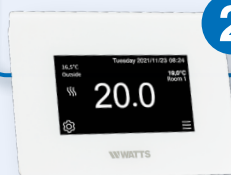

5 (or more) thermostats
D03 RF



HEATING SYSTEM 1

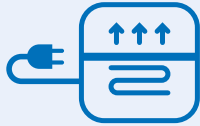

ELECTRIC FLOOR HEATING

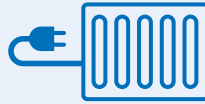

ELECTRIC RADIATOR



TOWEL DRYER



**2 receivers
WR02 RF**

5



**3 receivers
FR02 RF**

6





Vision® Wired

Application 4: Hydronic heating multizone

EQUIPMENT

- 2 Thermostats D03 or A03
- 1 Connecting box WFC-03 8Z HC
- Several actuators 22CX

INSTALLATION



MONO
ZONE



MULTI
ZONE



WIRELESS



WIRED



PRODUCTS

2 thermostats
D03 and A03



HEATING SYSTEM 1



BOILER



HEAT PUMP



HYDRONIC FLOOR HEATING



Connecting box
WFC-03 8Z HC

4



2 or more
actuators **22CX**

5





Vision® Wired

Application 5: Hydronic heating and cooling monozone

EQUIPMENT

- 1 Thermostat D03 to control Heat pump with live contact

INSTALLATION



MONO
ZONE



MULTI
ZONE



WIRELESS



WIRED



HEATING SYSTEM 1



HEAT PUMP

PRODUCT

**1 thermostat
D03**



TOOLS

Vision configurator

www.wattswater.eu/vision-configurator

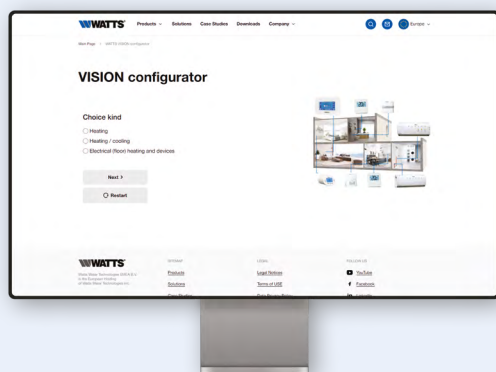

BIM objects

www.bimstore.co/manufacturers/watts

