

Safety groups SFR the range



- SAFETY GROUP, which is the group's purpose? How does it function?
- SFR the most complete range of hydraulic safety groups in Europe.
- Safety group SFR conception.
- The standard connections.
- The NF agreement.
- Connecting an hot water storage heater : Check-list.
- Essential accessories.

WATTS[®]
INDUSTRIES

A Division of Watts Water Technologies Inc.



Which is the safety group's purpose ? How does it function ? :

This appliance performs 4 functions:

- ✓ **Protecting** the hot water storage heater from pressure excess :
As the water temperature increases, the pressure also increases inside the hot water storage heater (dilation of the water).
For safety reasons, this pressure must be restricted to a value lower than the hot water storage heater's safety pressure.
This function is carried out by the safety valve which is set at 7 bar.
- ✓ **Isolating** the hot water storage heater from the cold water supply :
This function is carried out by the stop valve (also part of the Safety Group).
- ✓ **Preventing** a backflow of cold water into the cold water supply system :
A check valve prevents any backflow of hot water (which is under pressure in the hot water storage heater) into the cold water supply system, as soon as the pressure in the hot water storage heater becomes higher than that of the cold water supply.
- ✓ **Draining** the hot water storage heater :
The hot water storage heater is drained using the safety valve which can be activated manually, and once opened, the water held under pressure in the hot water storage heater is drained out.
(Caution : make sure that the electrical connection of the hot water storage heater has been previously disconnected. In addition, take precautions against burns during hot water drainage).

The drainage outlet on the Safety group, which comprises an air gap preventing any backflow of the drained water, should be connected to the drainage system.

A LEAK in the SAFETY GROUP DOES NOT MEAN THAT IT IS NOT WORKING. TO THE CONTRARY, THIS IS ONE OF ITS MAIN FUNCTIONS.

Frequent cases and explanations to detect what is normal or not:

☹️ **A - Every evening at the same time, the safety group installed on the hot water storage heater leaks. Is this normal?**

☺️ Yes, if the flow occurs whilst the hot water storage heater is heating, and about 30 minutes after the end of the heating cycle.

This is normal and the expected function by this safety component, which is the safety group.
This leak is due to the increase of volume by the expansion of water that is heated by the electrical immersion resistor in the hot water storage heater.
When water heats up, its volume increases, as does its pressure.

The safety group closes its non-return valve and thus impedes any return of hot water into the cold water supply circuit.

This is the non-return function of the safety group.

To compensate for the expansion of the water, for 7 bar, the safety group opens to let a little water flow out and thus to compensate for the expansion of the water.

It is therefore normal to find a trickle of water in the form of regular drops (corresponding with an average of 3% of the volume in the hot water storage heater).

☹️ **B - Every evening at the same time, the safety group installed on the hot water storage heater leaks, but in greater proportions. Is this normal?**

☹️ No. As explained above, to compensate for the expansion of the water, for 7 bar, the safety group opens to let a little water flow out and thus to compensate for the expansion of the water.

We should find a trickle of water in the form of regular drops, corresponding with an average of 3% of the volume in the hot water storage heater.

If there is a significant and permanent flow, the supply pressure of the network is too high at night (frequently due to lower water consumption at night).

It is then necessary to install a water pressure reducing valve (REDUFIX type) near the safety group.

It is also possible to install an expansion vessel that will absorb the expansion of water and avoid too great an opening of the safety group (see WATTS expansion vessels and WATTS connection kit, art. no. 2292503N).

☹ **C - Every evening, but also during the day at different times, the safety group installed on the hot water storage heater leaks: Is this normal?**

☹ The safety group opens and leaks as soon as the pressure reaches 7 bar.

There can therefore be two causes:

- The supply pressure is over 7 bar, since there is no pressure reducing valve on the cold water supply,
- The pressure reducing valve is leaking.

If you have a pressure reducing valve on your installation (where your water supply enters the house or near the hot water storage heater), it is usually set to 3 bar.

Thus, each time you open a hot water tap, you make the pressure drop in the hot water storage heater and bring the mains water back up to 3 bar.

Check this when the safety group is flowing, by opening a hot water tap and finding that the valve flows less and then not at all.

If you have a pressure reducing valve and the flow does not slow when you open a hot water tap, the probable cause is the pressure reducing valve leaking. It needs to be replaced.

☹ **D - What should I do if the safety group flows all the time?**

☹ This fault is due to there being a foreign body that prevents the valve from closing, or by the water being too corrosive or aggressive - and which damaged the safety group beyond repair.

It is usually a grain of sand, scale or a copper / brass shaving when work is being done on the plumbing or the installation.

These particles stick to the elastomer membrane of the valve and prevent the membrane from sealing against the valve face.

If the particle is not deeply embedded, you can try to remove it by opening the safety group knob completely.

Otherwise, call a professional plumber and have him dismantle the valve with a special tool and clean the membrane.

If the elastomer membrane is damaged or too deeply marked, the valve module should be changed or even the whole safety group.

These particles do not always come from the mains water and can come from sediment or particles of scale that form in the hot water storage heater with time.

Unfortunately, installing a sediment filter does not solve this type of problem completely.

If the plumber finds, as he dismantles the valve, that the valve facing has been attacked by corrosion due to poor water quality (cf. E.G. 60.1), it is necessary to change the safety group. You are then strongly advised to install a safety group with a SFR STAINLESS STEEL type (art. no. 2252570) or a SFR PTFE type (art. no. 2252560).

☹ **E - Is it possible for the safety group to open at a pressure of 3 or 4 bar?**

☺ No, safety groups made to French standards, and the SFR valves in particular, are designed to stringent specifications.

By their manufacture, the valve cannot open at a value of only 3 or 4 bar.

Each SFR safety group is manufactured, adjusted and checked individually in our BVQI (Bureau Veritas Quality International) ISO9001 certified factory.

The valve is set to 7 bar according to the NF standard. The tolerance required by this standard cannot be below 6.65 bar.

☹ **F - The safety group installed on 2 hot water storage heaters in series or in parallel (frequent in solar installations) is very hot. Is this normal?**

☹ We do not allow our safety groups to be used on installations of hot water storage heaters in series or in parallel.

Our safety groups have the advantage of a French standard right of use (NF EN 1487 NF-D 36401) and are thus intended, like all NF safety groups, for connection to a household cold water supply.

For installations using an installation of hot water storage heaters in series, we recommend the installation of household safety valves with a setpoint conforming to the hot water storage heater manufacturer's recommendations.

For solar installations, there are valves that are specially adapted for high temperatures (WATTS SV/E model).

G - A **water hammer** (a banging you can hear) is produced **when I shut a tap** of my installation.
What should I do?

In the present installations, the use of increasing numbers of fast-closing appliances (single-control mixer tap, push-handle taps, washing machine solenoid valve, 1/4 turn taps, etc.) aggravate this phenomenon.

These are the cause of a significant increase of water hammers, leading to:

- Rapid wear of equipment, sometimes even their sudden deterioration.
- Noises that do not comply with the present acoustic standards.
- Damage to the pipes and risks of leaks at the joints.

H - What is the difference between a standard safety group and the **SFR STAINLESS STEEL**?

The SFR STAINLESS STEEL safety group is an upmarket appliance, the result of many encounters with professional plumbers. It meets with on-the-job problems found by plumbers and private persons, especially caused by water quality problems, increasingly aggressive and hard water.

- The stainless steel seat eliminates the risk of corrosion and any problems with the valve.
- The body of the SFR Stainless steel valve is equipped with a flat section above the drainage, which facilitates its installation and fitting direction.

When a water hammer happens, the safety group might open to release a little water. When this happens, at the same time, a few particles in the water can be trapped between the valve facing and the elastomer membrane, thus causing a leak.

It is necessary to have one or several anti-hammer devices installed as near as possible to the appliance causing the water hammer (single-control mixer tap, push-handle taps, washing machine solenoid valve, 1/4 turn taps, etc.).

We recommend the choice of pneumatic anti-hammer devices that are more efficient than the spring models.

- The valve, in the form of a removable module, can be changed with a special wrench (tool reserved to professional plumbers), without having to dismantle the entire valve unit.
- Its STAINLESS STEEL valve seat is practically invincible to all water qualities. Once the valve is dismantled, it is easy to clean the facing and re-screw the valve module. The safety group is immediately operational again.

The SFR, SFR Stainless steel, SFR PTFE, SFR Multi group, SFR angle body Stainless steel, and GSM1" safety groups comply with standard NF-EN 1487 and have the advantage of the right to using the NF mark (NF EN1487 NF-D 36401).

Stainless steel Safety group SFR design

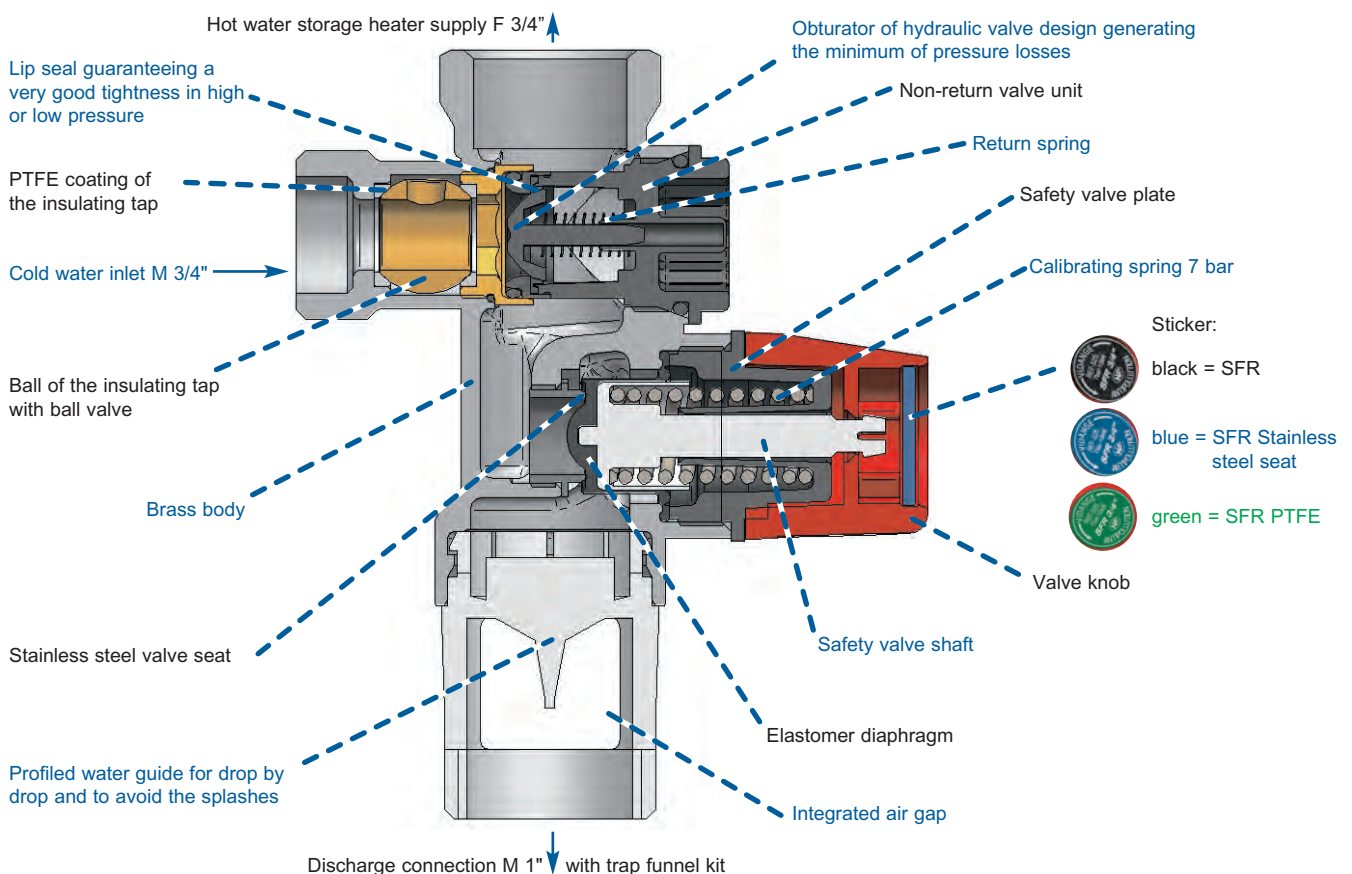















☹ I - Which safety group should I choose for which water quality?

☺ The hardness of water in France is expressed in concentration by weight degree of hardness. One TH of 1°F (French degree) is equivalent to 10 grams

of limestone per cubic metre. Soft water is more aggressive and therefore more corrosive than hard water. Hard water leaves more solid scale, which clogs appliances and degrades the water tightness of equipment. For this reason, a removable and interchangeable valve is an advantage.

SFR the most complete range of hydraulic safety groups in Europe.

Types of hot water storage heater						
Water qualities	small capacities on or under the sink max. power 4 kW	on vertical stand max. power 10 kW	vertical on the wall max. power 10 kW	horizontal on the wall max. power 10 kW	on horizontal stand max. power 10 kW	horizontal big capacity max. power 18 kW
normal water	SFR NA53M2 1/2" art. no. 2254310M2  Angle body model art. no. 2254311M2	SFR 3/4" art. no. 2252550 		SFR 3/4" stainless steel seat angle body art. no. 2252571 		GSM 1" angle body art. no. 2254557 for UK 
hard water	SFR NA53M2 1/2" stainless steel seat, art. no. 2254312M2 	SFR 3/4" PTFE art.no.2252560 	SFR 3/4" stainless steel seat art.no.2252570 	SFR Multi group 3/4" stainless steel seat straight or angle body art.no. 2252573 	SFR 3/4" stainless steel seat angle body art. no. 2252571 	GSM 1" angle body art. no. 2254555 for France and Belgium. 
aggressive water	Angle body model 1/2" stainless steel seat art. no. 2254313M2 	SFR 3/4" stainless steel seat art. no. 2252570 	SFR Multi group 3/4" stainless steel seat straight or angle body art. no. 2252573 	SFR Multi group 3/4" stainless steel seat straight or angle body art. no. 2252573 		GSM 1" angle body art. no. 2254555 for France and Belgium. 

The standard connections:

A : without sanitary expansion vessel

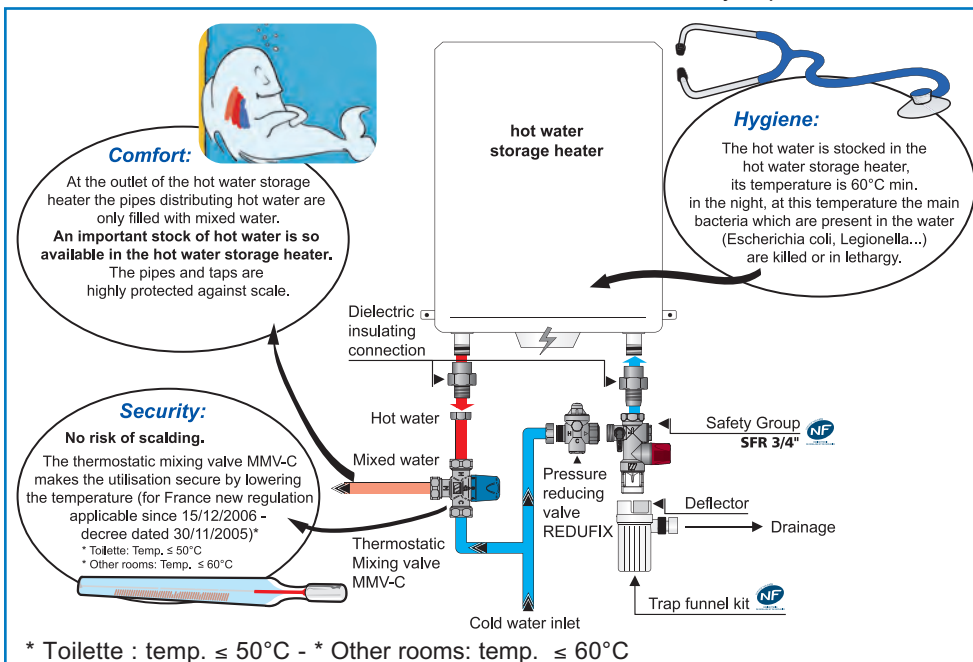

Complete set for hot water storage heaters DN 1"1/4 max. power 24 kW art.no. 2254562 (UK) or art.no. 2254560 (F-B)



GSE 3000

1/2" 15 mm EN1488

* Toilette : temp. ≤ 50°C - * Other rooms: temp. ≤ 60°C

B : with sanitary expansion vessel (cf question B)

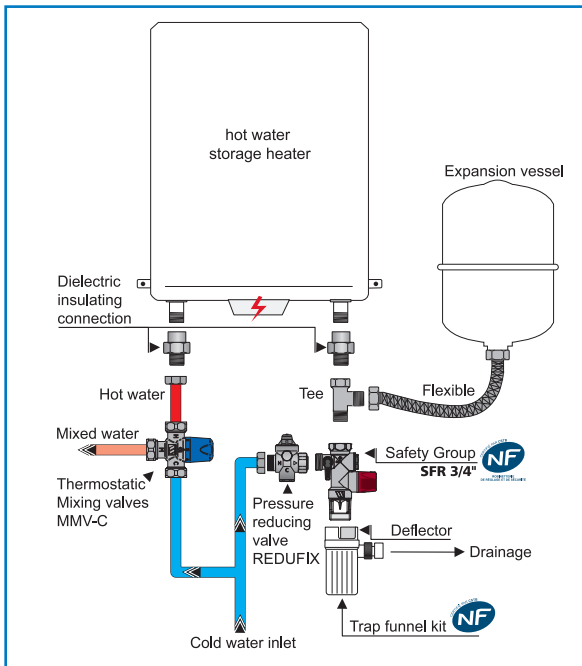

C : with horizontal hot water storage heaters

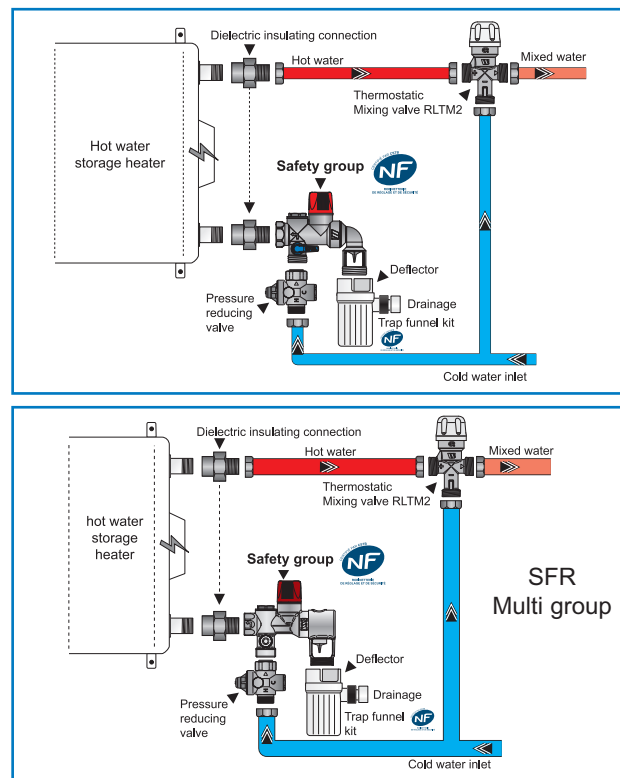

RECOMMENDATIONS / INSTALLATION

- 1 - Make sure there is no seal mastic, oakum or other waste preventing its proper working.
- 2 - Operate the isolating valve and safety valve at least once a month.
- 3 - The drain pipe should be 25 mm minimum. A suitable tundish/airgap (not supplied) should be fitted.
- 4 - If the cold water supply pressure exceeds 3 bar, a pressure reducing valve should be fitted UPSTREAM of the safety group. Please refer to the range available from Watts Industries.
- 5 - This Safety group may be fitted to a hot water storage heaters of maximum 10 kW working power. (except GSM1" art. no. 2254555 for hot water storage heaters until 18 kW).
- 6 - Subject to plumbing regulations.
- 7 - To prevent the two metal corrosion phenomenon, fitting Dielectric Unions on piping between the hot water storage heater and the safety group as well as the hot water storage heaters hot water outlet is recommended. Please refer to the range available from Watts Industries.

INSTALLATION EXAMPLE WITH THE MIXED WATER DISTRIBUTED

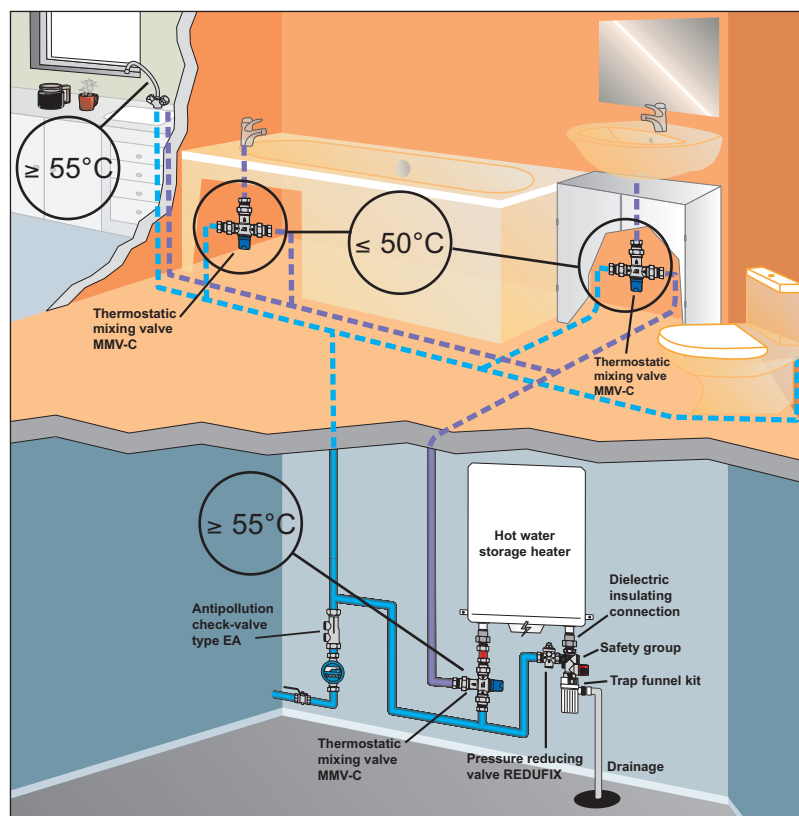

Connecting an hot water storage heater:

Check-list for memory

1 The Safety group:

Main safety device, **its installation is mandatory** (NF D 36 401 standard).

This appliance performs 4 functions:

✓ **Protecting** the hot water storage heater from excess pressure :

As the water temperature increases, the pressure also increases inside the hot water storage heater (dilation of the water).

For safety reasons, this pressure must be restricted to a value lower than the hot water storage heater's safety pressure.

This function is carried out by the safety valve which is set at 7 bar.

✓ **Isolating** the hot water storage heater from the cold water supply :

This function is carried out by the stop valve (also part of the Safety group).

✓ **Preventing** a backflow of cold water into the cold water supply system:

A check valve prevents any backflow of hot water (which is under pressure in the hot water storage heater) into the cold water supply system, as soon as the pressure in the hot water storage heater becomes higher than that of the cold water supply.

✓ **Draining** the hot water storage heater: The hot water storage heater is drained using the safety valve which can be activated manually, and once opened, the water held under pressure in the hot water storage heater is drained out.

(Caution : make sure that the electrical connection of the hot water storage heater has been previously disconnected.

In addition, take precautions against burns during hot water drainage).

The drainage outlet on the Safety group, which comprises an air gap preventing any backflow of the drained water, should be connected to the drainage system.

2 Pressure reducing valves:

This reduces the pressure of the water that crosses it and provides an outlet pre-set and constant value. The REDUFIX model protects, in particular, the hot water storage heater and it is factory pre-set. During the night, when the pressure of the water distribution system increases (at night the pressure of the water distribution system increases with the reduction in the number of water consumers), the pressure reducing valve protects the hot water storage heater against excess pressure, as well as prevents the opening of the Safety group valve.

4 The trap funnel kit:

As indicated by its name this part works as a trap : the screwing part is placed directly under the Safety group at the threaded male discharge in 1" (26x34).

The smooth part, to be glued, is connected to the drainage.

This trap complies with the requirements of the NF standard, with a sufficiently sized air gap and water gap, protecting the bad odours from evaporation.

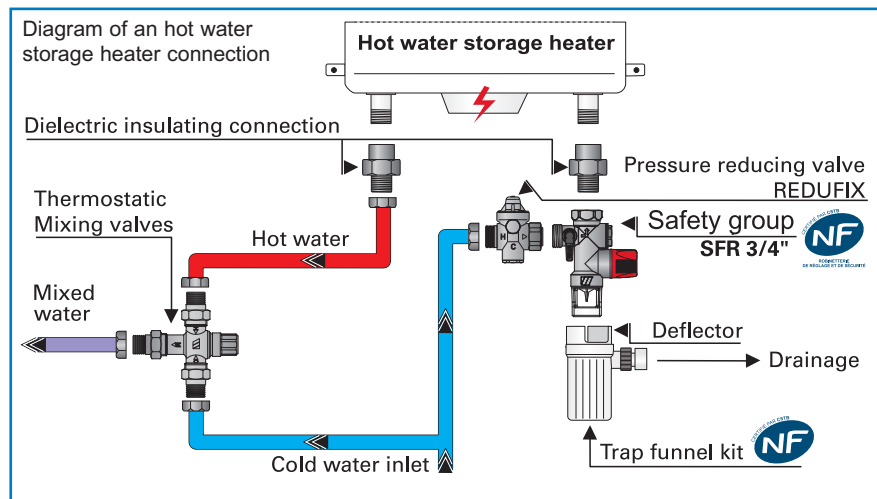

3 Dielectric insulating connection:

Two different metals, copper and steel (for example), coming in contact in an equipment results in corrosion risk. Copper and its alloys (such as brass) are cathodic, which associated with other metals foster "battery" phenomena and, as a result, cause faster corrosion and circulation of stray currents.

The dielectric insulating connections provide connection of cold water tubulature (made of steel) of the Safety group hot water storage heater (made of brass) without creating a "battery" phenomenon.

This union fitting is removable, which facilitates installation.

We also recommend that the hot water outlet of the hot water storage heater is protected with a dielectric insulating connection.

The Watts Industries dielectric insulating connections meet the requirements of the D.T.U. in the framework of the implementation of protection against the corrosion of some pipes including steel and copper components; in particular, this is the D.T.U 60.1 regarding sanitary plumbing in buildings.

5 The thermostatic mixing valves:

This unit automatically mixes the hot water in the hot water storage heater with the cold water in the water supply system.

It provides several functions:

- **Safety:** it automatically provides and stabilizes mixed water at the selected temperature.

- **Saves hot water:** the hot water pipe lines are only filled with mixed water. A large supply of hot water is still available. The pipes and taps are highly protected against lime scale.

- **Scald protection:** rapid failsafe if cold water supply is interrupted.

- **Compliance with regulations:** It satisfies the obligations imposed by the Ministry decree of 30th November 2005, applicable as from 15th December 2006, prohibiting any water distribution at a temperature over 50°C at the point of use in bathrooms. Adjusting the appliance (to be done only once at the time of installation) is facilitated by the handle button: Lowering of the temperature by turning clockwise, increase of the temperature by turning anti-clockwise. The appliance is fitted with built-in non-return valves.



Safety groups SFR, SFR PTFE and SFR Stainless steel



Compliant with standards NF EN 1487 (F), BELGAQUA (B).



SFR

The fruit of much work with plumbing contractors and manufacturers of hot water storage heaters, the SFR will be of great interest to professionals and fully meet the most demanding expectations.

SFR 3/4" PTFE for calcareous hard water quality:

PTFE seat contributing to limit the risks of scaling.

SFR 3/4" Stainless steel for calcareous, hard and aggressive waters:

This « top-of-the-range », safety group features a stainless steel seat to prevent corrosion from impairing the valve seal. SFR Stainless steel is recommended especially where water is aggressive, hard or even calcareous.

model	presentation	art. number
SFR 3/4" (20x27)	box	2252550
SFR PTFE 3/4" (20x27)	box	2252560
SFR Stainless steel 3/4" (20x27)	box	2252570

Advantages

1. Fast filling rate of more than 4000 L/h under 1 bar.
2. Less head loss, greater convenience for users.
3. Valve knob designed for excellent grip.
4. New valve seat limits risk of leaks by efficient clearance of foreign matter.
5. Dimensions make the group interchangeable with the major safety groups on the market.
6. Swivelling air gap designed to protect the wall from water splashes regardless of the type of mounting.
7. For hot water storage heaters up to 10 kW maximum useful power.

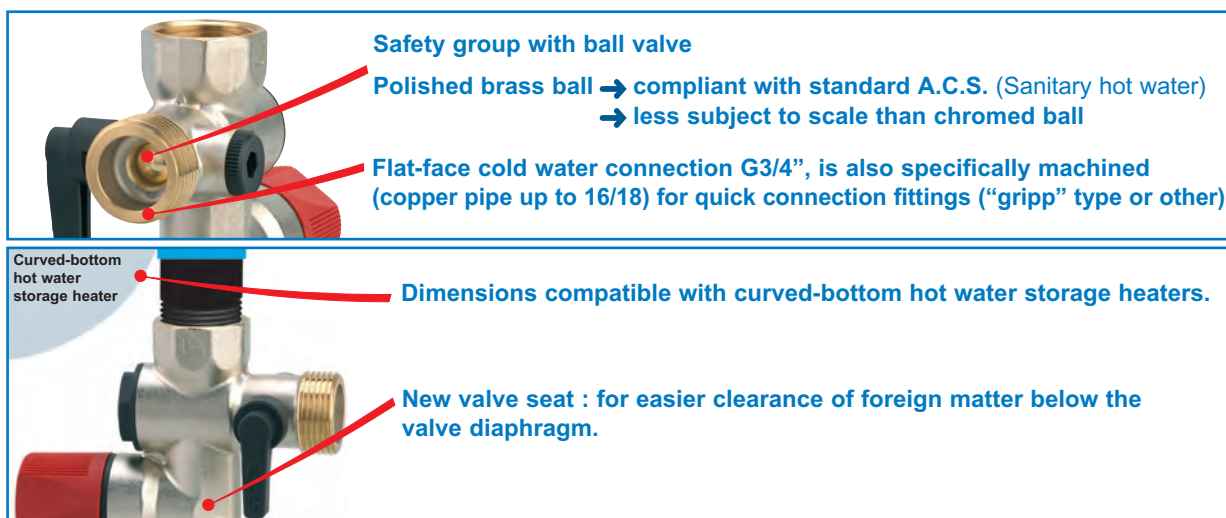

Conception

- 1 Female port, Ø 3/4" 20x27 for mounting on the hot water storage heater with a Dielectric Insulating Connection (WATTS INDUSTRIES "RID").
- 2 Check valve inspection port.
- 3 Check valve : built into safety group to allow intake of cold water into hot water system and stop return of hot water into the mains.
- 4 Quarter-turn isolating ball valve.

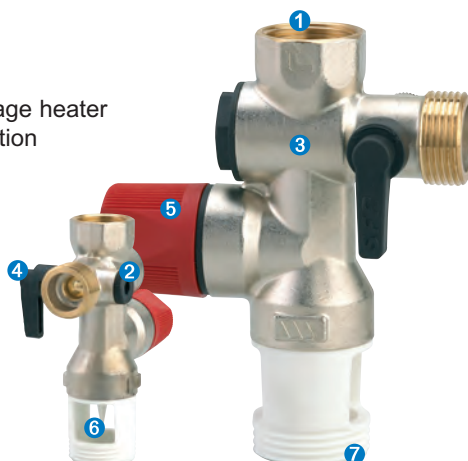

- 5 Expansion relief valve: limits pressure in the hot water storage heaters. Set to 7 bar. Instant opening, "POP" effect, guarantees very high outflow rate.
- 6 Water guide : nozzle profile prevents any risk of splashing.
- 7 Safety valve discharge port with air gap. 1" thread (26x34).

Dimensions (in mm) art. no. : 2252550 / 2252560 / 2252570

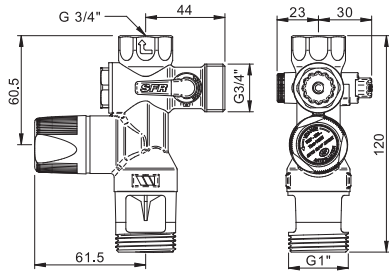

Pressure drop curve / headloss

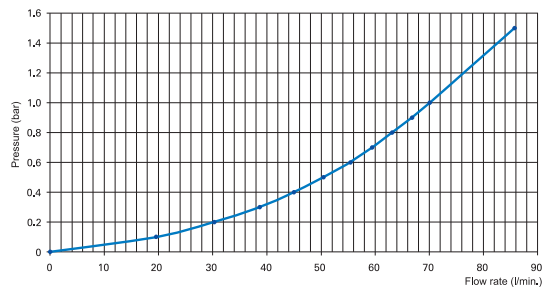

Safety groups NA53M2

New safety groups 1/2" (15x21).
Special for hot water storage heater small capacities on or under the sink, 1/2" fitting.
For hot water storage heater until 4 kW max. power.
Delivery with air gap threaded G1" DN 20.

Compliant with standards
NF EN 1487 (F),
BELGAQUA (B).

diameter	presentation	type	art. number
1/2" (15x21)	plastic bag	NA53M2	2254310M2
1/2" (15x21)	plastic bag	NA53M2 angle body	2254311M2
1/2" (15x21)	plastic bag	NA53M2 stainless steel seat	2254312M2
1/2" (15x21)	box	NA53M2 angle body stainless steel seat	2254313M2



Safety group SFR 3/4" angle body Stainless steel

Characteristics identical to the SFR Stainless steel but with orientable discharge port air gap.
Particularly adapted to the "stable" or "horizontal" hot water storage heaters because in this configuration of installation the valve is more subjected to the risks of scaling or filling by the impurities such as sand or silica.

Compliant with standards
NF EN 1487 (F),
BELGAQUA (B).

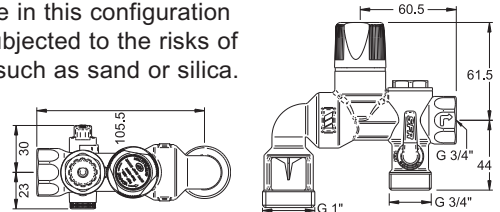

diameter	presentation	art. number
3/4" (20x27)	box	2252571



New

Safety group SFR Stainless steel *multi*group

New and patented, **SFR multi group** allows to transform the straight safety group into angle body version for the horizontal hot water storage heater.

Compliant with standards
NF EN 1487 (F),
BELGAQUA (B).

SFR multi group : 1 product answers the 2 possibilities, vertical or horizontal assembly.

The dimensions are perfectly interchangeable with the safety groups SFR 3/4" angle body stainless steel.

- Only 1 product in stock.
- Stainless steel seat.
- Dielectric insulating connection (dismountable).
- Interchangeable with the SFR 3/4" angle body.

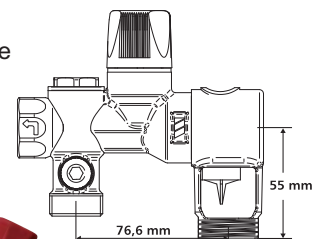

vertical or horizontal assembly



orientable discharge port with air gap, facilitates the installation

diameter	presentation	art. number
3/4" (20x27)	box	2252573



Safety group angle body GSM 1"

Safety group with diaphragm. Model high capacity.
Soupape à levée progressive.
For hot water storage heater 1" (26x34) of max. power rating: 18 kW.

Flow rate 5 m³/h.

Orienable metallic angle discharge port with air gap.
Particularly adapted to the "stable" or "horizontal" hot water storage heater because in this configuration of installation the valve is more subjected to the risks of scaling or filling by the impurities such as sand or silica.

- Set pressure: 6 bar for UK.
- Set pressure: 7 bar for France and Belgium.

Compliant with standards
WRAS (UK), NF EN 1487 (F),
BELGAQUA (B).

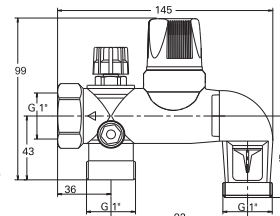

diameter	set pressure	presentation	art. number
1" (26x34)	6 bar (UK)	box	2254557
1" (26x34)	7 bar (F-B)	box	2254555

art. no. 2254562 (UK) or
art. no. 2254560 (F-B)



art. no. 2293202

Complete Set for hot water storage heater DN1 1/4

This complete set for hot water storage heaters with high capacity includes:

- 2 safety groups GSM 1" (Compliant with standards WRAS (UK), NF EN 1487 (F), BELGAQUA (B).
- 2 connection brass sets
- 2 chromed fittings MM 1"
- 2 trap funnel kits with deflector

For high capacity hot water storage heaters of max. power rating 24 kW.

diameter	set pressure	presentation	art. number
Complete set 1 1/4 (UK)	6 bar (UK)	box	2254562
Complete set 1 1/4 (F-B)	7 bar (F-B)	box	2254560
Connection brass set alone 1 1/4		box	2293202



art. no.
2292315

art. no. 2292324

Trap funnel kits for safety groups

Trap funnel kits with deflector.

The trap of water protects from all phenomena of bad smells due to evaporation.

Compliant with standard NF for art. number 2292315.

type	presentation	art. number
standard NF	plastic bag	2292315
short hot water storage heater special restoration	plastic bag	2292324



Dielectric insulating connection R.I.D.

Union fitting avoid the phenomenon of pile between 2 metals of different nature.
To prevent accelerated corrosion and deterioration.

Male / Female (steel and brass).

Maxi. pressure: 16 bar.

Temperature : 110°C at 10 bar.

Electric insulation until 600 volts.

Tested and recommended by APAVE.

Dielectric Insulating Connection special for small hot water storage heaters

1/2" Female
(direct fitting on the hot water storage heater)
3/4" Male
(direct fitting on the safety group)

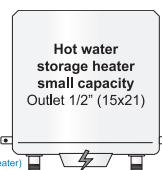

Art. no. 2224347

NF Safety group
Female 3/4" (20x27)



diameter steel to screw	diameter brass	type	art. number
F 1/2" (15x21)	M 3/4" (20x27)	RID	2224347
F 1/2" (15x21)	M 1/2" (15x21)	RID	2224331
F 3/4" (20x27)	M 3/4" (20x27)	RID	2224332
2 unions F 3/4"	M 3/4" (20x27)	under hull self-service	2224433



Pressure reducing valves REDUFIX

Pressure reducing valve with cloth diaphragm. Maintenance free.
 Can be set from 1,5 to 5 bar, factory preset (4 bar at Robust appliance.
 zero discharge for 3 bar working). Max. inlet pressure: 15 bar.
 DZR brass body. Diaphragm and seals EPDM & NBR. Max. temperature: 70°C.
 Ideal for protecting hot water storage heaters and household appliances (washing machine, dishwasher, ...). Female 1/4" pressure gauge outlet.
 The REDUFIX can be fitted in any position.

diameter	presentation	art. number
M/F 3/4" union nut (20x27)	box	2282210
M/F 3/4" union nut (20x27)	under hull self-service	2282211



Thermostatic mixing valves MMV-C (MMV-Compact)

Compact thermostatic mixing valve designed to supply general purpose applications with tempered water not exceeding a set temperature. Max. inlet pressure: 10 bar.
 Max. static pressure : 0,2 to 5 bar.
 Max. temperature: 85°C
 Save hot water and allowing to distribute the sanitary hot water at a selected and constant temperature (from 30 to 65°C). Temperature setting range: 30 to 65°C.
 Flow rate at 3 bar : 57 l/min (flow mini. : 5 l/min.).
 Handwheel with set positions (graduated scale Min to Max - 5 setting positions).
 Fitted with 2 check valves.



Easily installed thermostatic mixing valve : union nuts dismantable.
 Can be installed in any position.
 DZR Brass body. Stainless steel spring .

Rapid fail safe on either hot or cold water supply failure comply with EN1111 and EN1287.
 (BS1415 Pt 2 - TMV2).

diameter	connections	cap	finish	art. number
body 1" with G 1/2" male union threaded		graduated scale	nickel plated	2297134
body 1" with G 3/4" male union threaded		graduated scale	nickel plated	2297136
body 1" - DN 25 male threaded		graduated scale	nickel plated	2297138

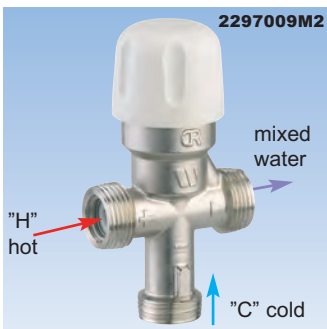

Adjustable thermostatic mixing valves RLTM2

RLT M2 is used also to control the temperature in a sanitary hot water distribution system with a hot water storage heater. Max. inlet pressure: 10 bar.
 Max. temperature: 85°C.
 Save hot water and allowing to distribute the sanitary hot water at a selected and constant temperature. Temperature setting range: 25 à 55°C.
 DZR Brass body. Very compact device. Flow rate 38 l/min at 3 bar.
 L-pattern valve (considered convenient for many system configurations).
 • Integrated check valves (model M/M/M 3/4").
 • Mixed water outlet on the side (cold water inlet by bottom).



Rapid fail safe if cold water supply is interrupted comply with EN1111 (the minimum differential between hot water inlet & the mixed temperature must be 20°C).
 (Δ Hot water/Mixed water > 20°C).

Installation : The hot and cold water pressures must be balanced for a correct mixing.
 Integral check valves for protection against cross-flow (size Female 1/2" delivered without check-valves).



diameter	presentation	flow rate	setting range	type	art. number
M/M/M 3/4" (20x27)	box	38 L/min at 3 bar	25 to 55°C	RLT	2297009M2
F/F/F 1/2" (15x21)	box	38 L/min at 3 bar	25 to 55°C	RLT	2297152



Complete installation set for hot water storage heater

Including:

- 1 safety group SFR 3/4" (NF)
- 1 trap funnel kit with deflector (NF)
- 2 metal flexible devices 40 cm, M/F 20x27 to connect hot water and cold water.
- 1 plastic flexible device 40 cm to connect the drainage with 2 ends.
- 1 fixation set for wall hot water storage heaters (screws and pegs).

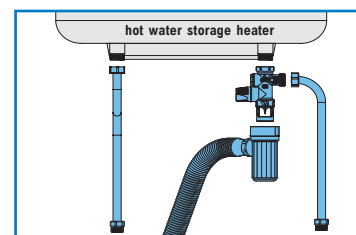

presentation	art. number
under hull self-service	2254603



Mounting plate on the back

Sanitary expansion vessel WATTS type AR N for hot water storage heater

Sanitary expansion vessel of white color.
Interchangeable membrane pressure (food quality).
Fittings: male 3/4" (20x27) or 1" (26x34) for 22AR25N.
Flat sealing (easy connect on flexible).
Max. inlet pressure: 10 bar.
Preload pressure: 3 bar. Max. temperature: 99°C.
Guarantee 24 months.



fixer la platine murale sur le mur



glisser le vase sur sa platine

le vase est fixé

Practical rules of vessel to be installed:

Temperature used	Hot water storage heaters capacity					
	50 L	100 L	150 L	200 L	300 L	500 L
60°C	1 x 22AR5N	1 x 22AR5N	1 x 22AR8N	1 x 22AR8N	1 x 22AR12N	1 x 22AR18N
70°C	1 x 22AR5N	1 x 22AR5N	1 x 22AR8N	1 x 22AR12N	1 x 22AR18N	1 x 22AR25N
80°C	1 x 22AR5N	1 x 22AR8N	1 x 22AR12N	1 x 22AR18N	1 x 22AR25N	2 x 22AR18N

For a cold water inlet with a pressure reducing valve tared at 3 bar.

capacity	fitting	Ø vessel (mm)	height (mm)	Preload pressure	art. number
5 Litres	M 3/4"	160	304	3 bar	22AR5N
8 Litres	M 3/4"	200	316	3 bar	22AR8N
12 Litres	M 3/4"	280	295	3 bar	22AR12N
18 Litres	M 3/4"	280	456	3 bar	22AR18N
24 Litres	M 1"	280	489	3 bar	22AR25N



Connecting set for sanitary expansion vessel WATTS type AR N

Allows the connection of sanitary expansion vessel WATTS type AR N of 5, 8, 12 or 18 litres to a hot water storage heater.

Set including :

- 1 flexible device length 50 cm - F3/4" x F3/4"
- 1 special tee of derivation brass MMF 3/4"

diameter	presentation	art. number
3/4" (20x27)	under bag self-service	2292503N

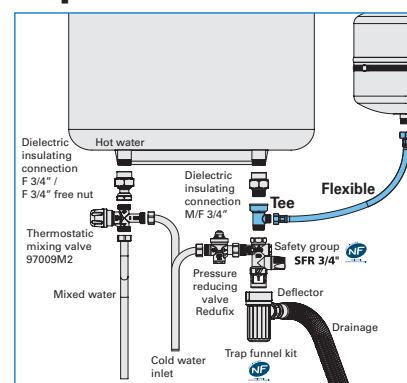

The photographs, illustrations and descriptions contained in this brochure are given for information only.
Watts Industries reserves the right to change the technical specifications or the design of these products without prior notice.